

Sagebooks Character Tracing Sheet 2.1 Traditional

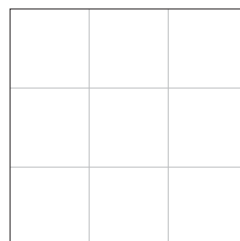

Sagebooks Character Tracing Sheet 2.1 Traditional

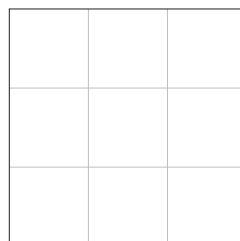
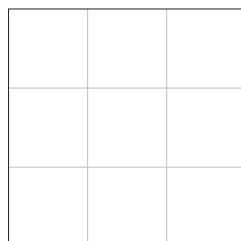
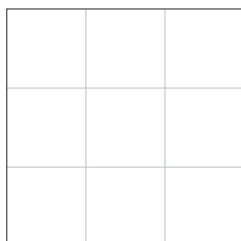
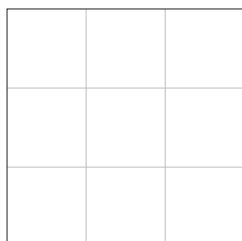
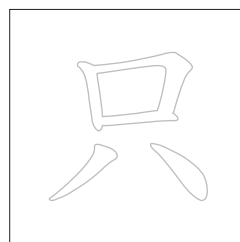
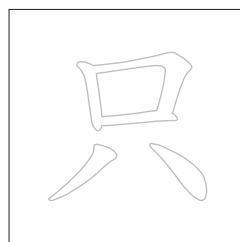
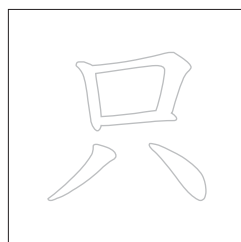
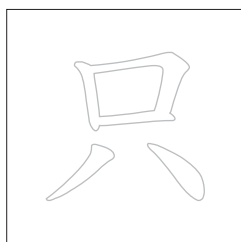
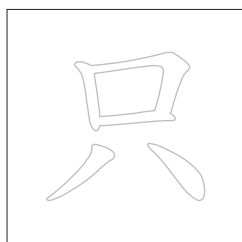
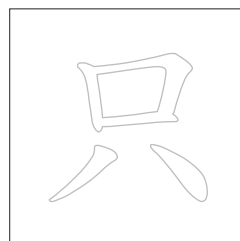
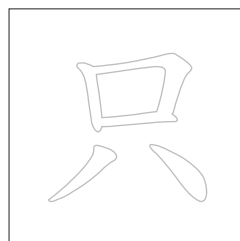
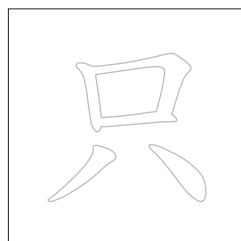
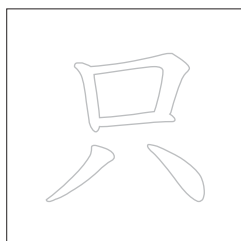
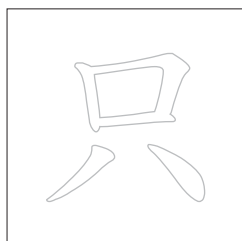
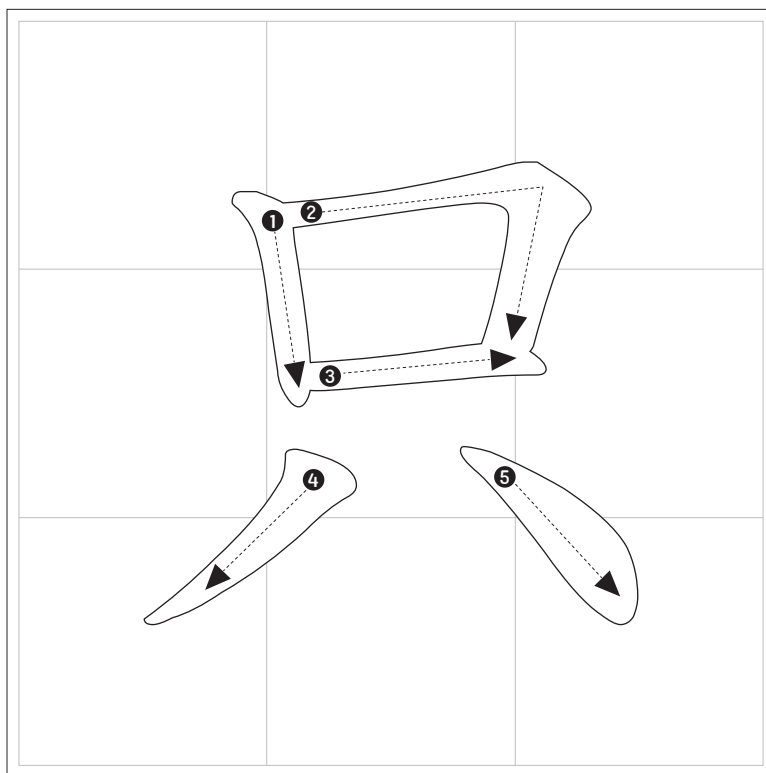
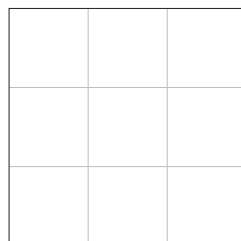
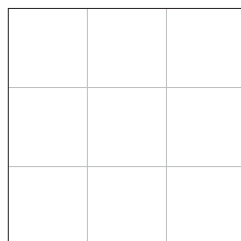
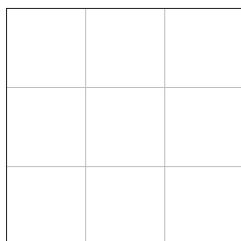
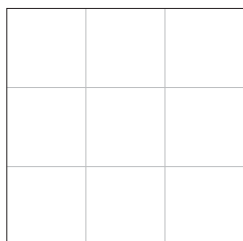
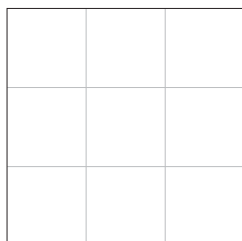
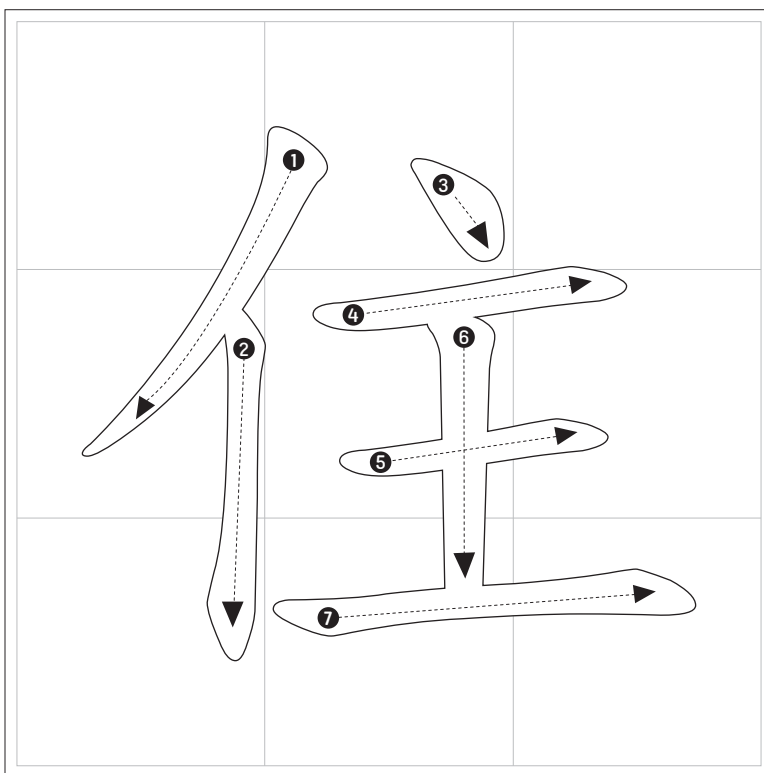

Sagebooks Character Tracing Sheet 2.1 Traditional

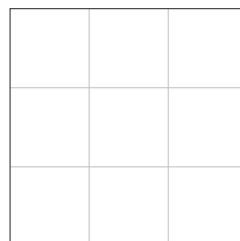
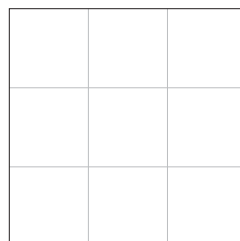
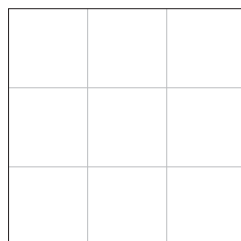
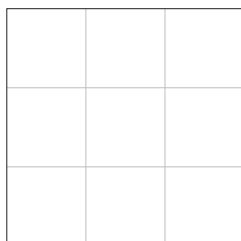
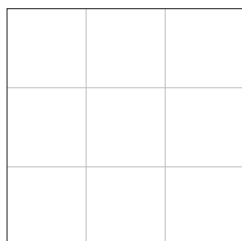
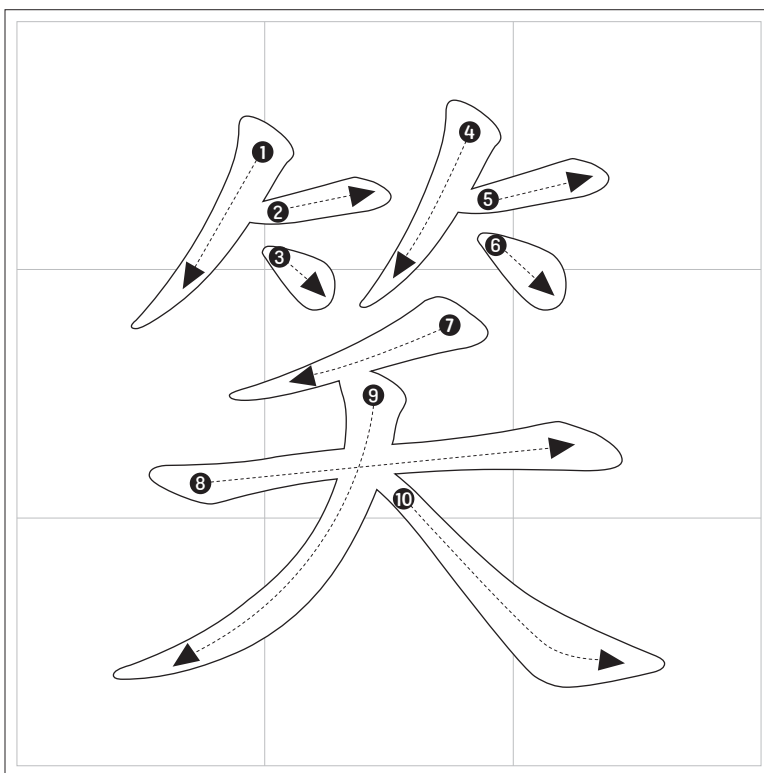

Sagebooks Character Tracing Sheet 2.1 Traditional

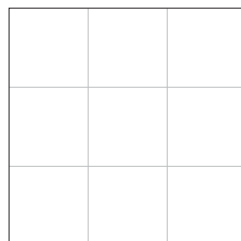
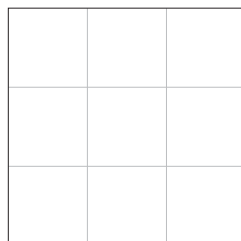
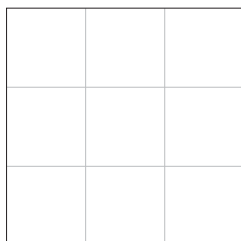
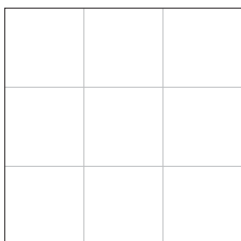
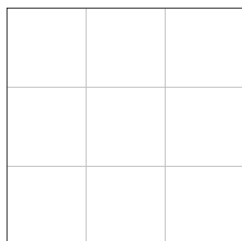
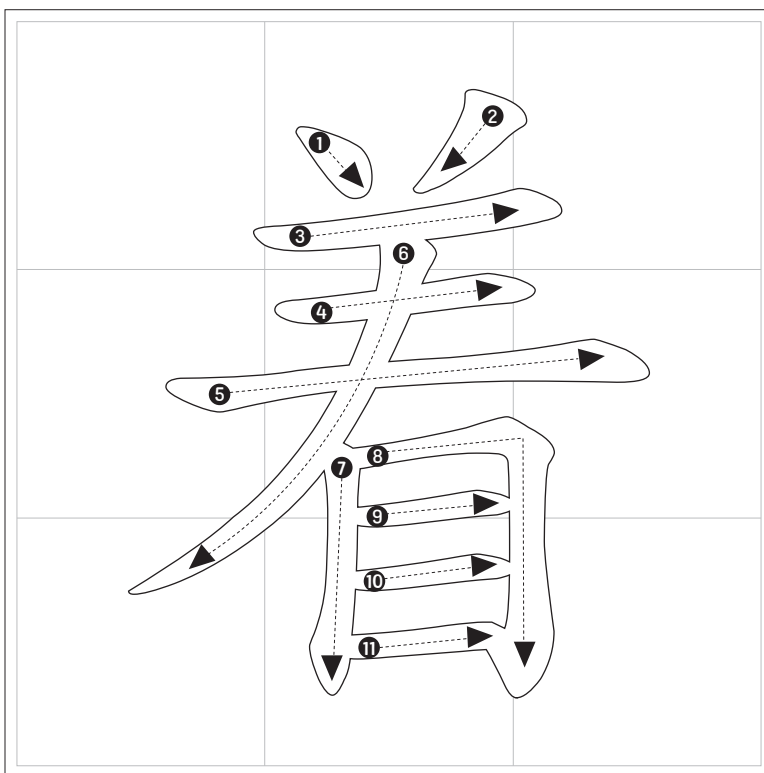

Sagebooks Character Tracing Sheet 2.1 Traditional

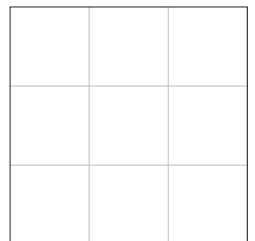
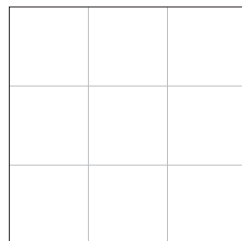
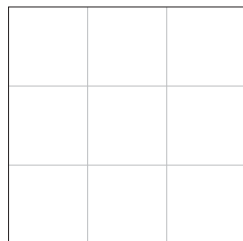
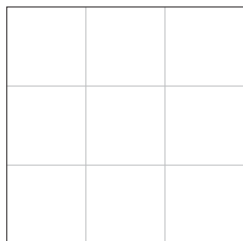
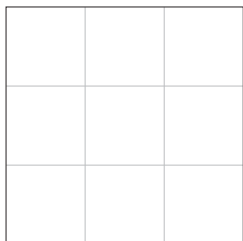
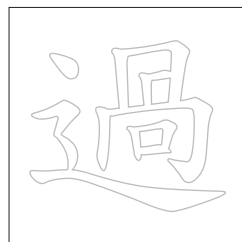
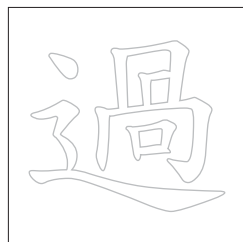
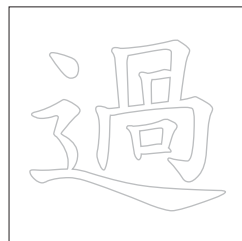
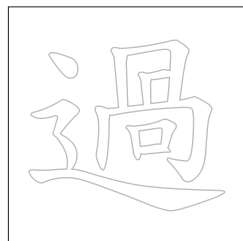
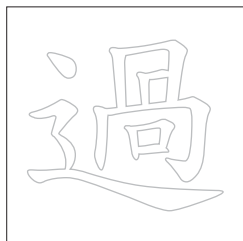
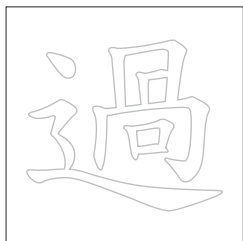
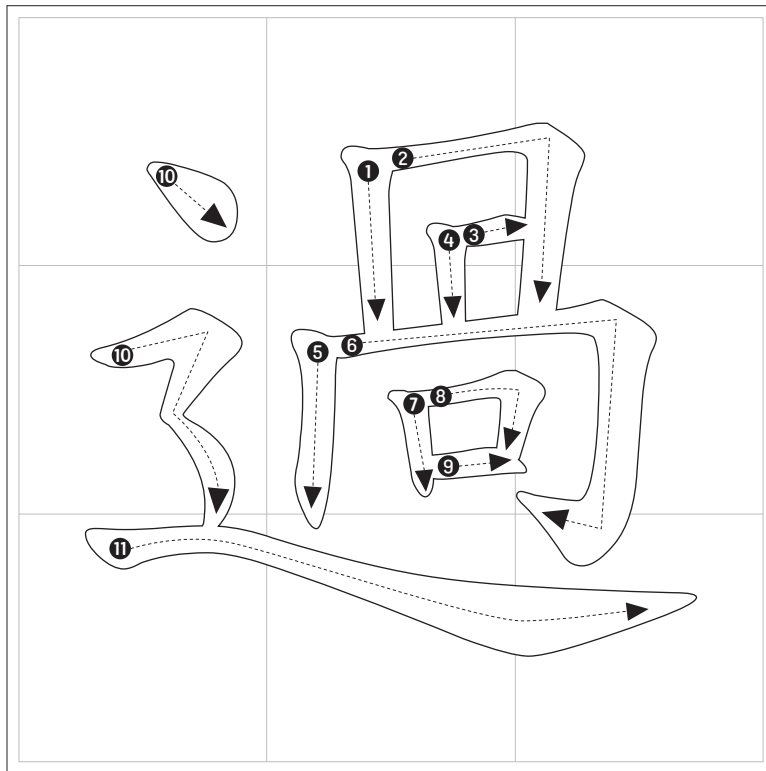

Sagebooks Character Tracing Sheet 2.1 Traditional

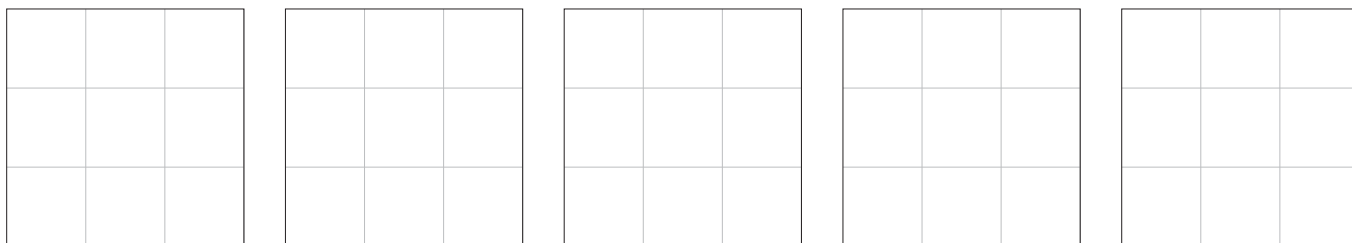
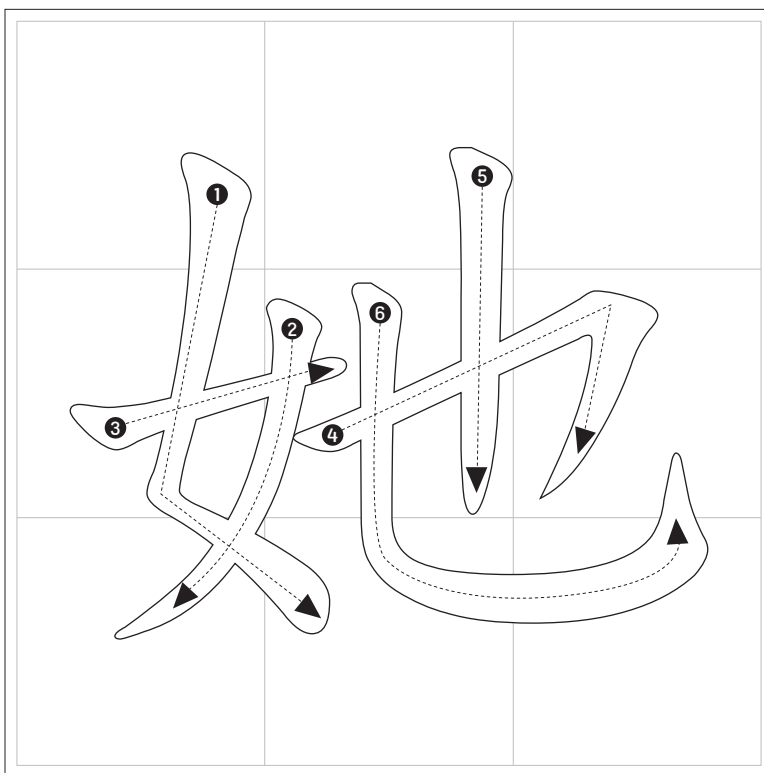

Sagebooks Character Tracing Sheet 2.1 Traditional

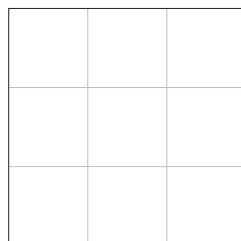
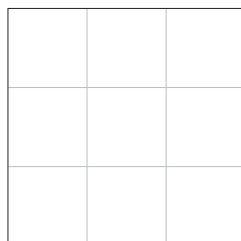
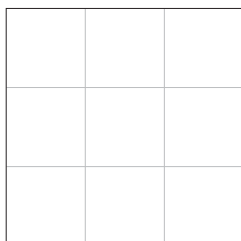
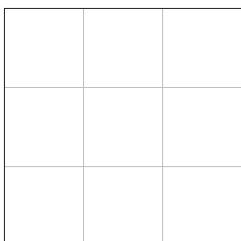
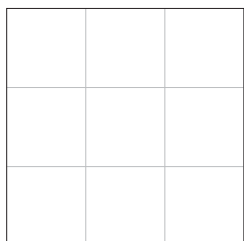
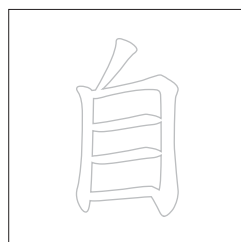
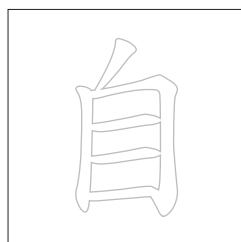
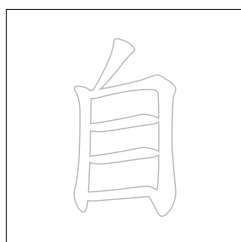
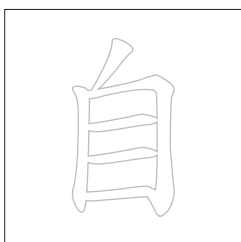
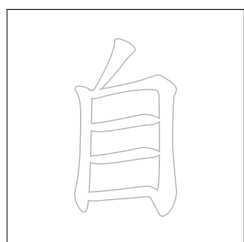
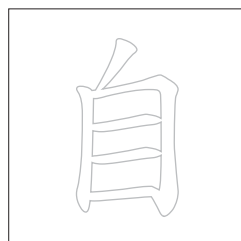
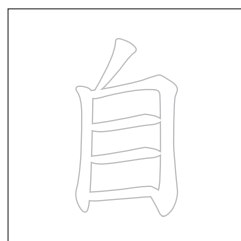
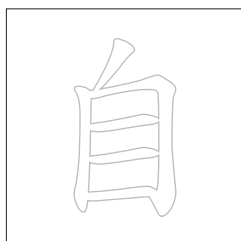
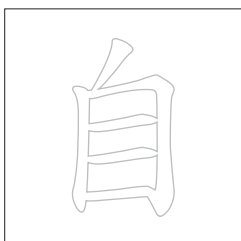
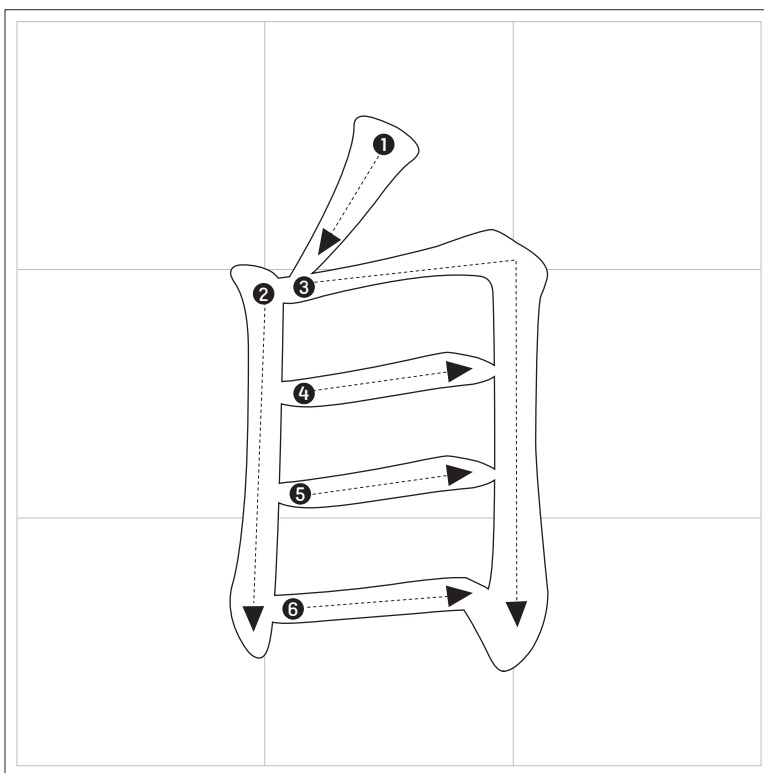

Sagebooks Character Tracing Sheet 2.1 Traditional

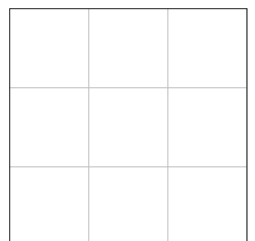
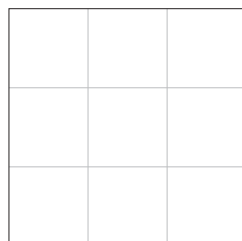
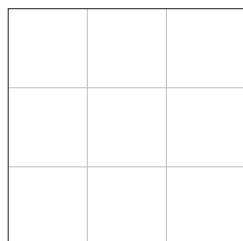
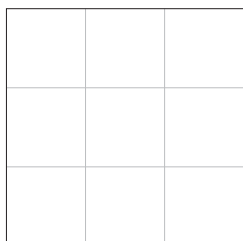
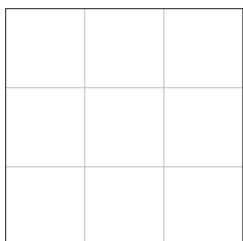
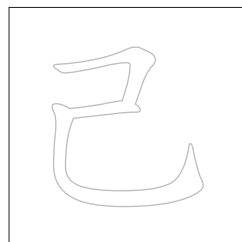
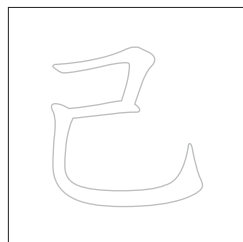
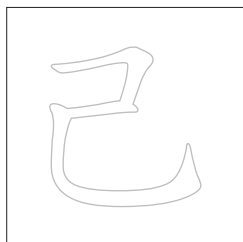
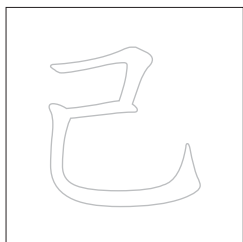
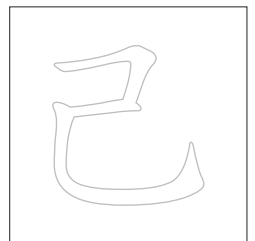
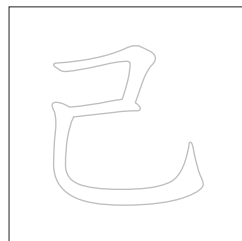
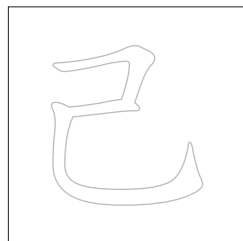
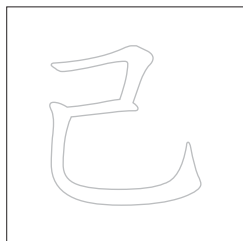
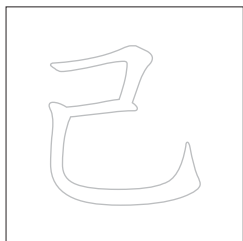
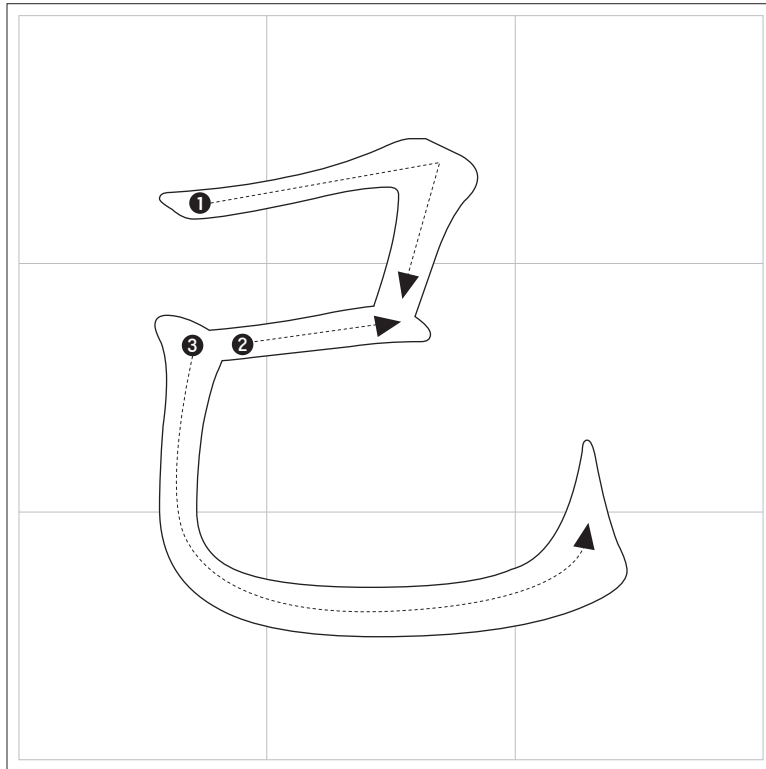

Sagebooks Character Tracing Sheet 2.1 Traditional

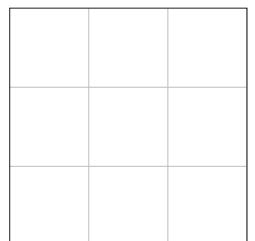
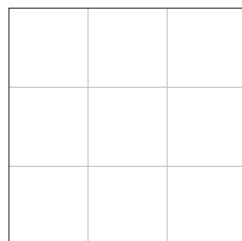
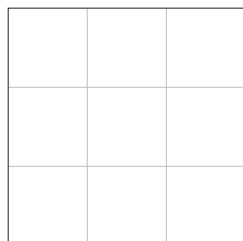
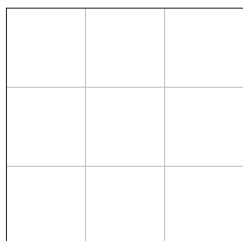
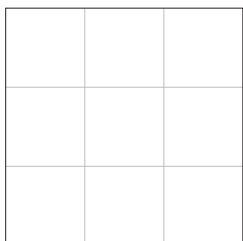
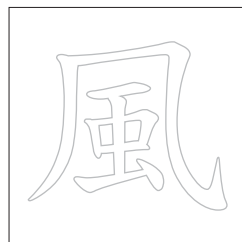
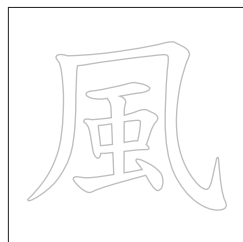
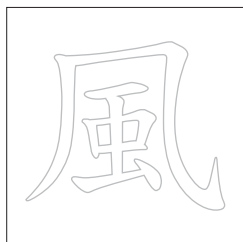
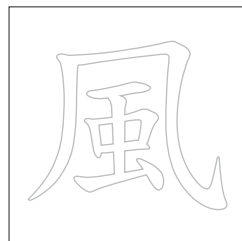
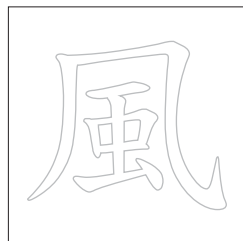
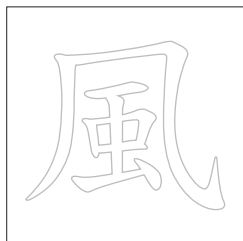
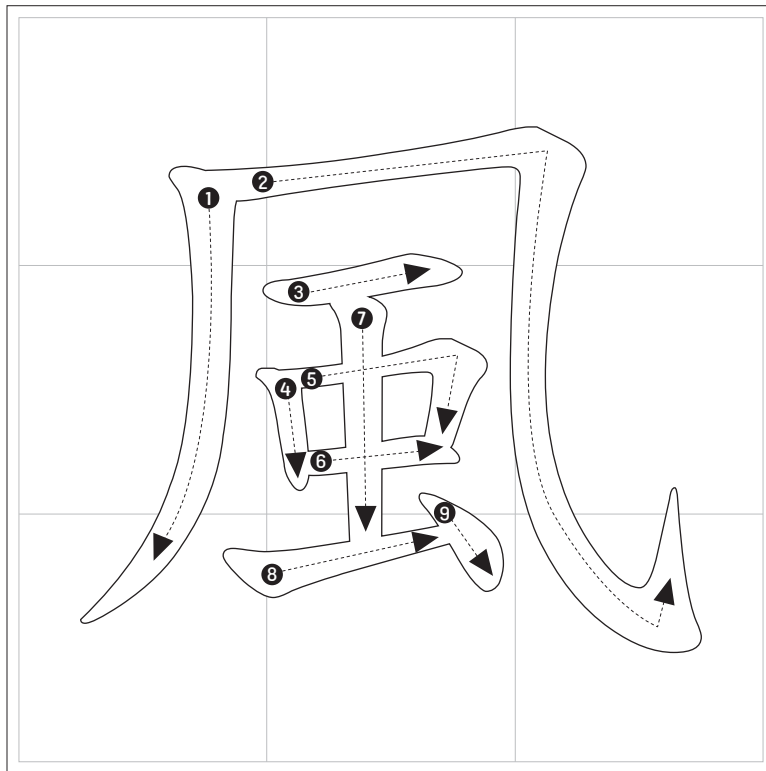

Sagebooks Character Tracing Sheet 2.1 Traditional

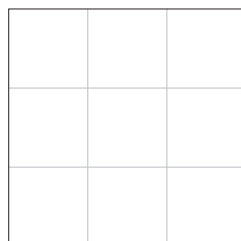
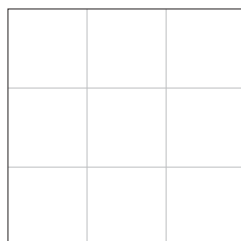
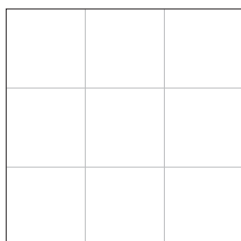
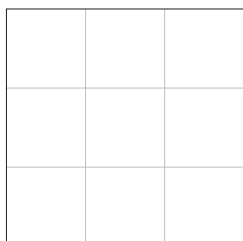
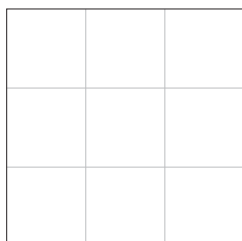
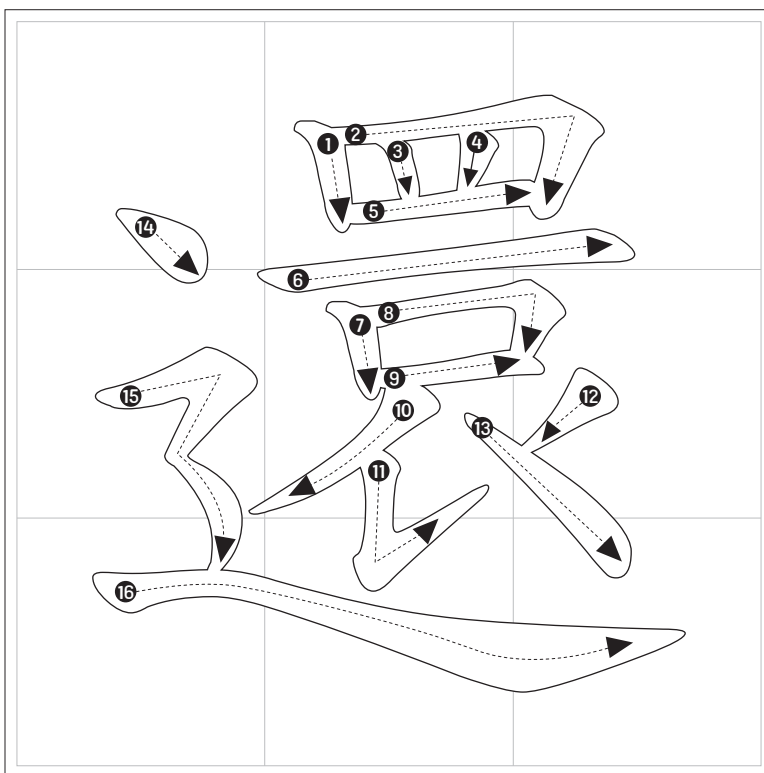

Sagebooks Character Tracing Sheet 2.1 Traditional

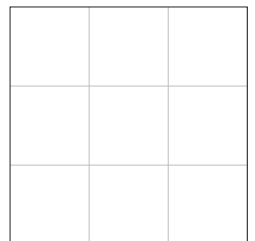
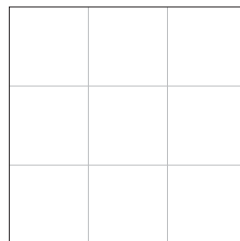
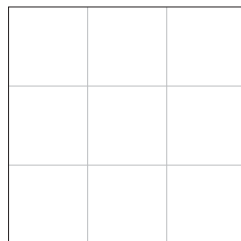
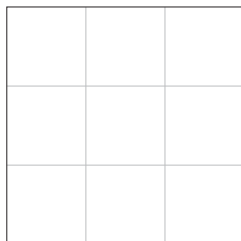
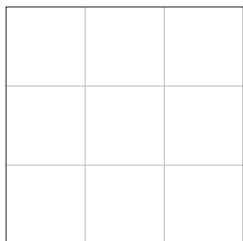
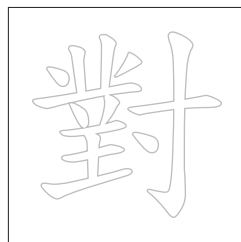
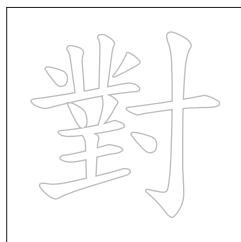
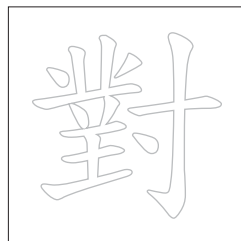
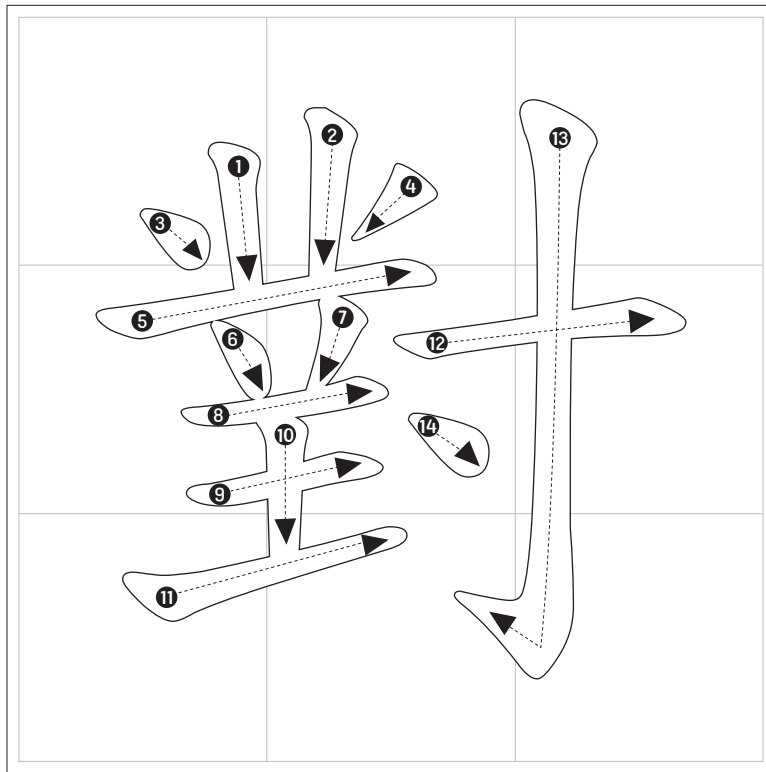

Sagebooks Character Tracing Sheet 2.1 Traditional

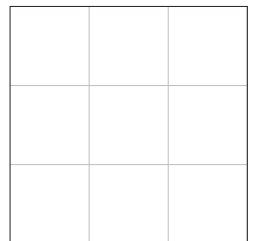
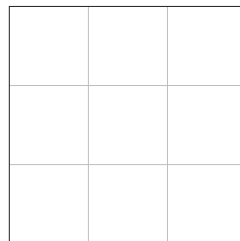
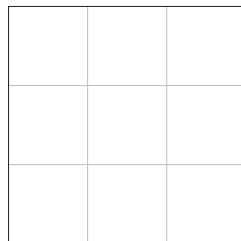
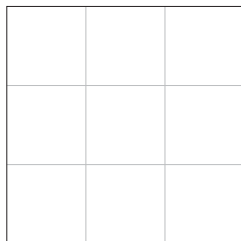
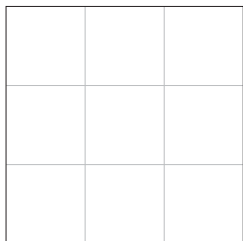
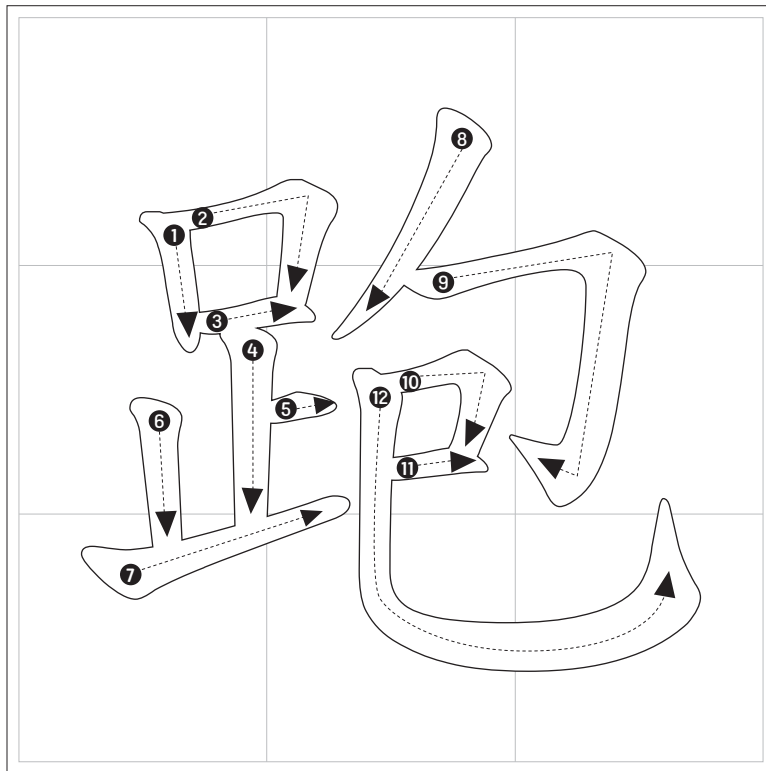

Sagebooks Character Tracing Sheet 2.1 Traditional

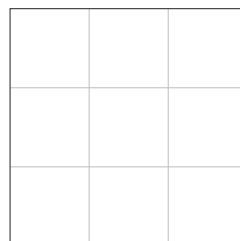
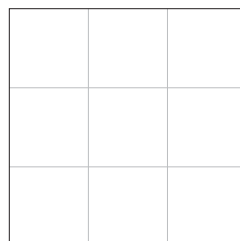
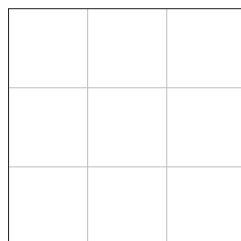
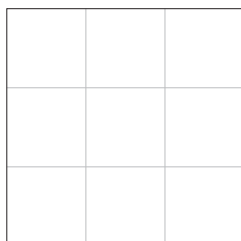
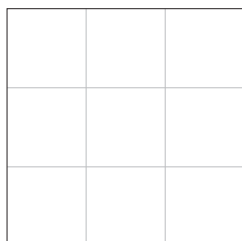
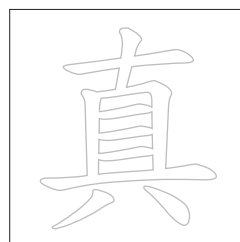
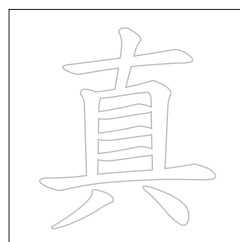
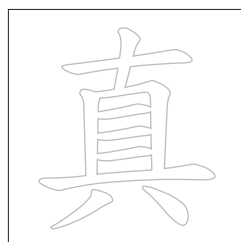
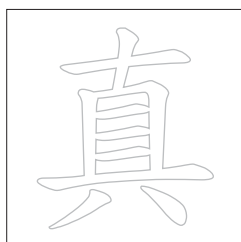
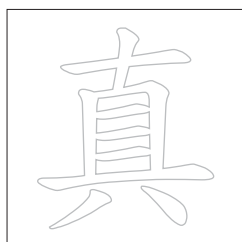
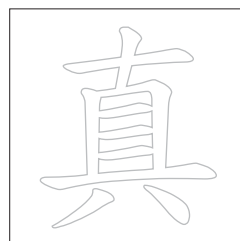
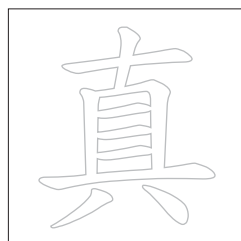
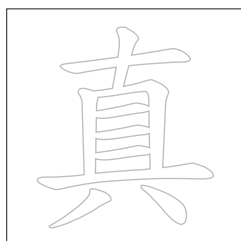
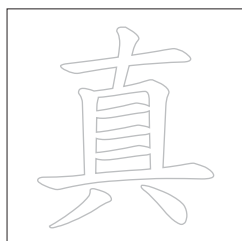
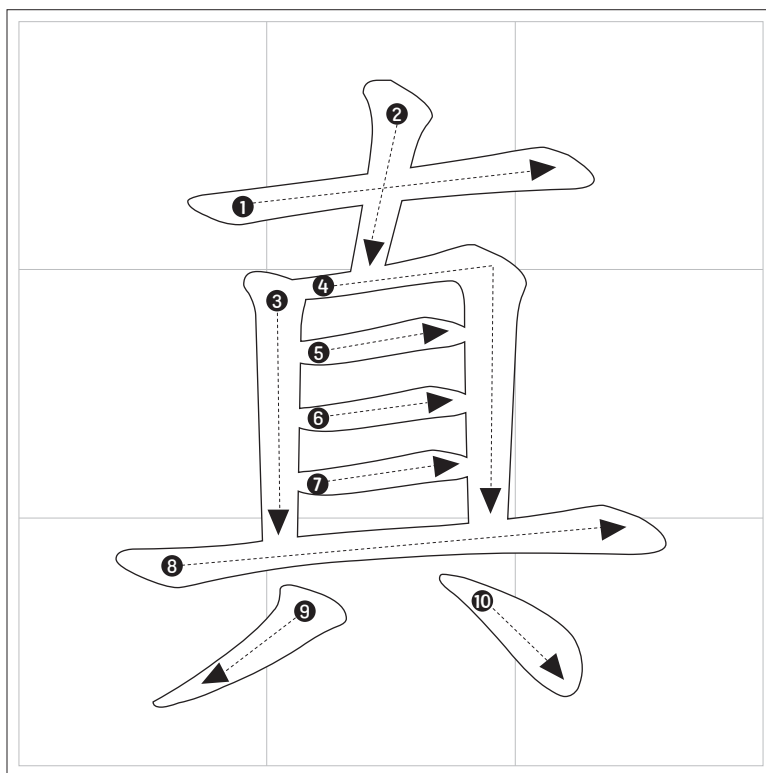

Sagebooks Character Tracing Sheet 2.1 Traditional

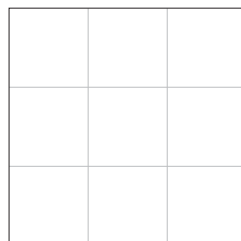
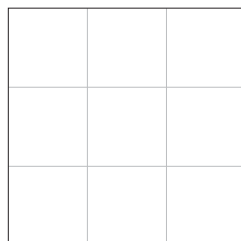
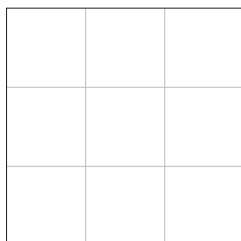
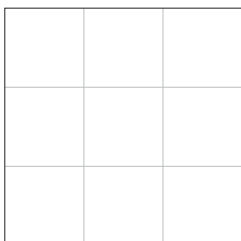
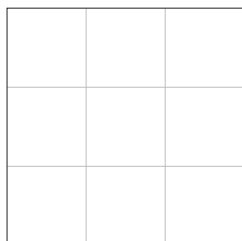
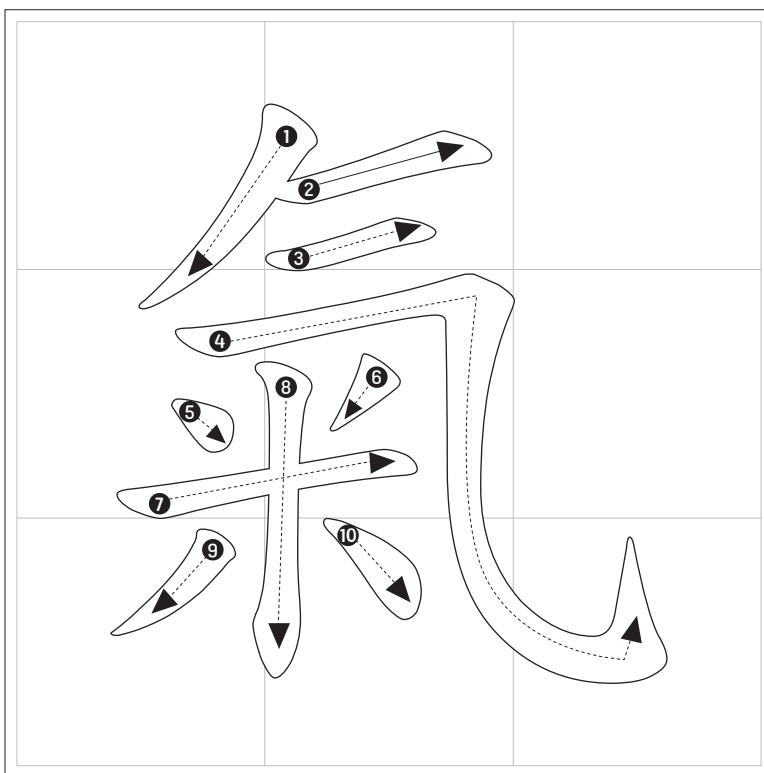

Sagebooks Character Tracing Sheet 2.1 Traditional

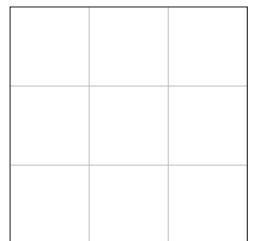
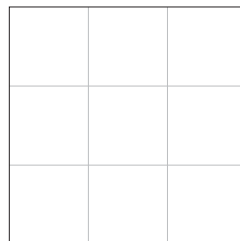
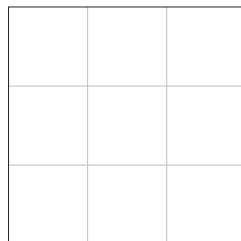
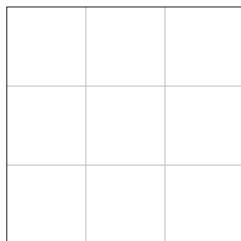
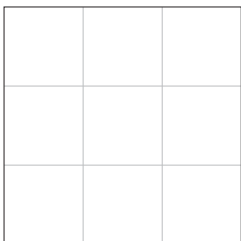
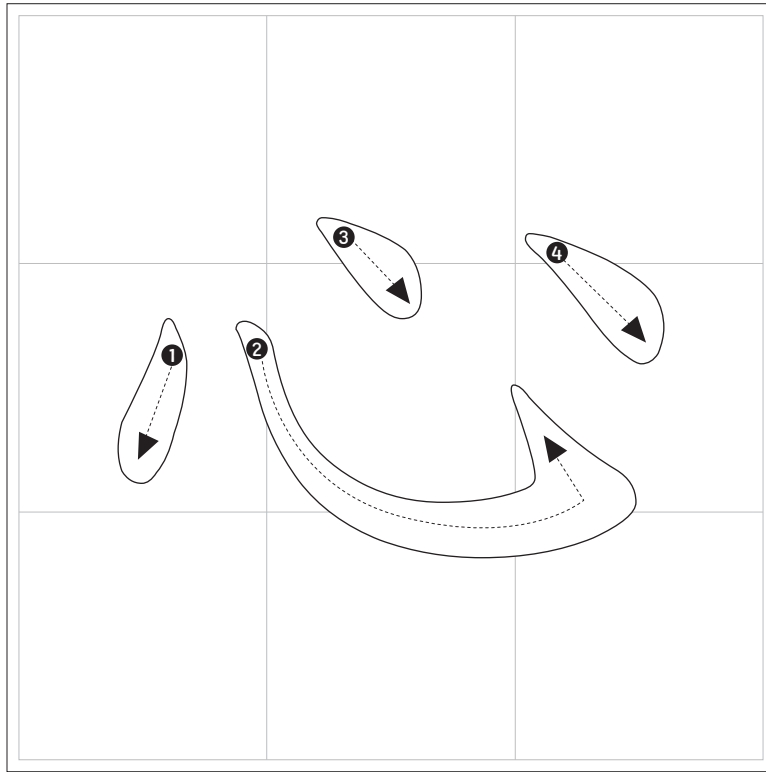

Sagebooks Character Tracing Sheet 2.1 Traditional

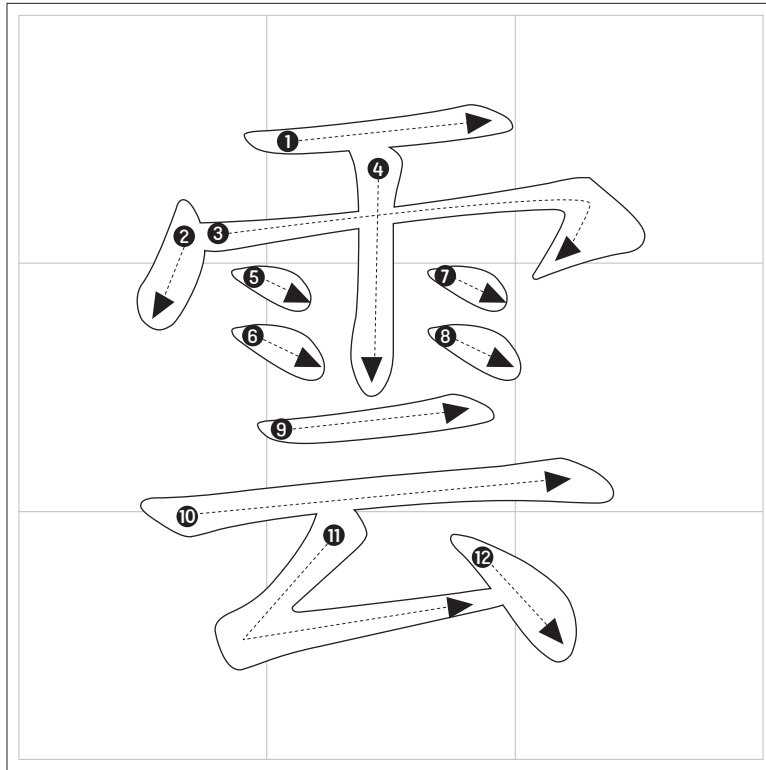

| | | | | |
|--|--|--|--|--|
| | | | | |
| | | | | |
| | | | | |

Sagebooks Character Tracing Sheet 2.1 Traditional

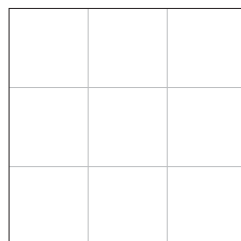
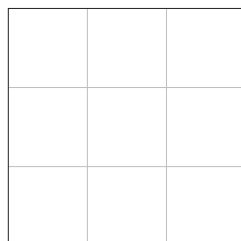
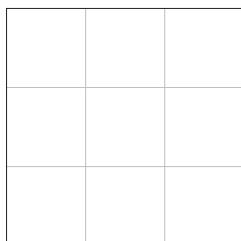
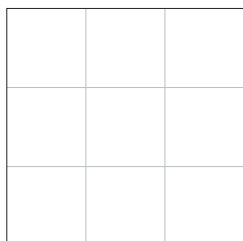
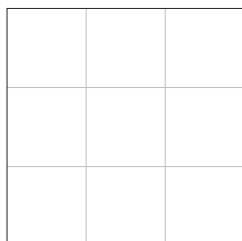
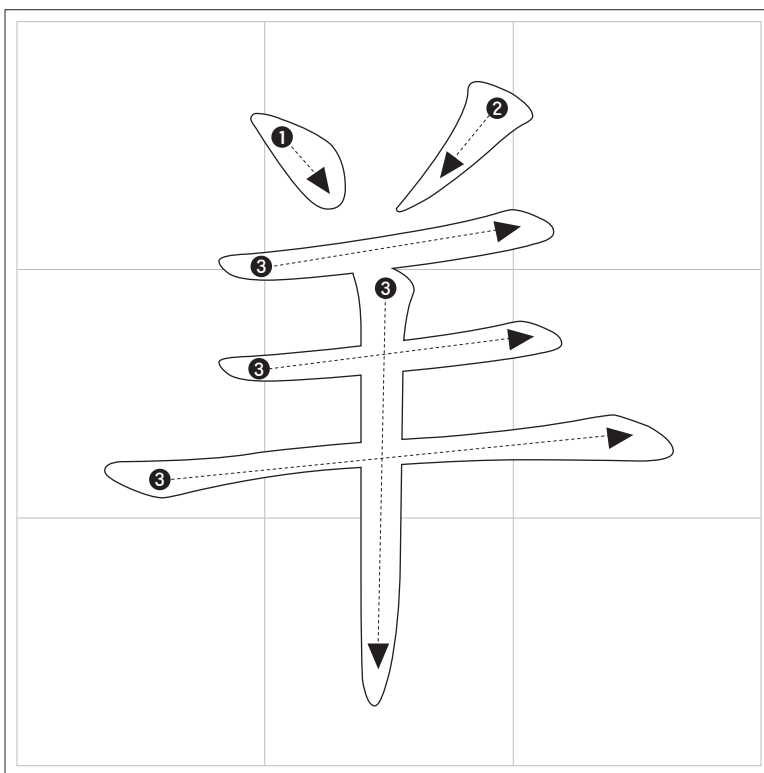

Sagebooks Character Tracing Sheet 2.1 Traditional

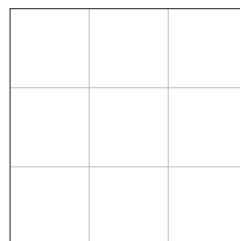
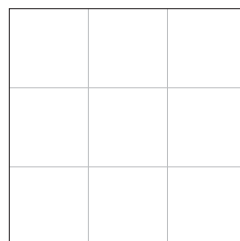
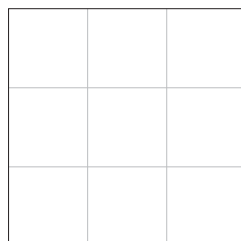
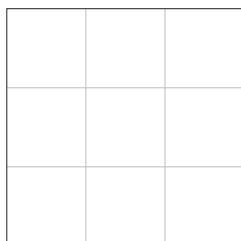
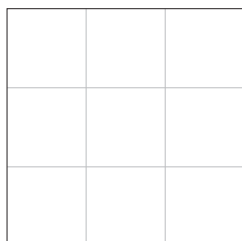
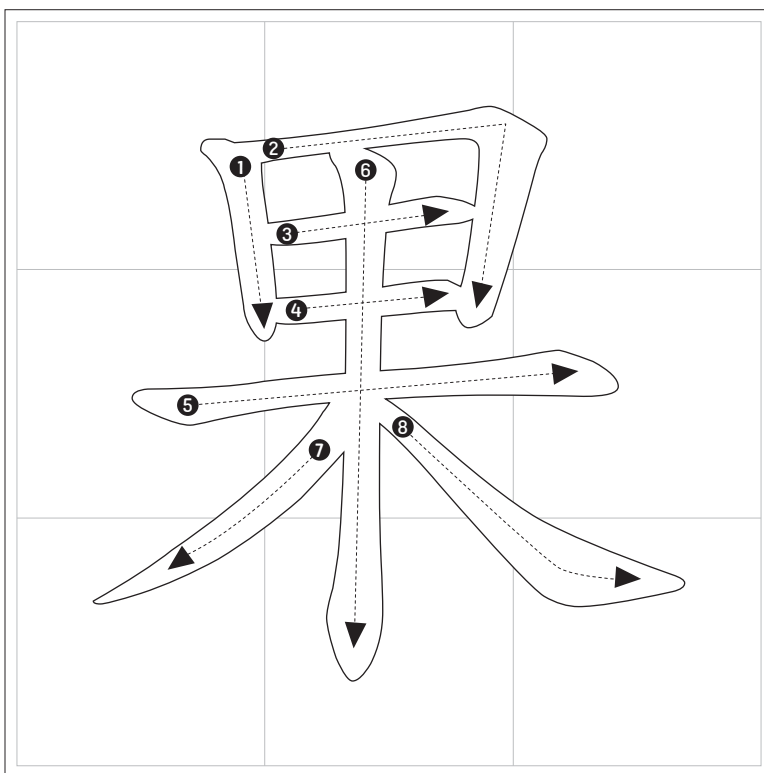

Sagebooks Character Tracing Sheet 2.1 Traditional

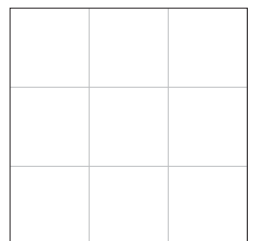
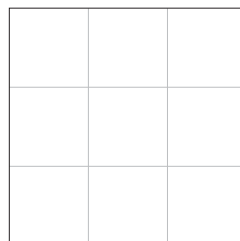
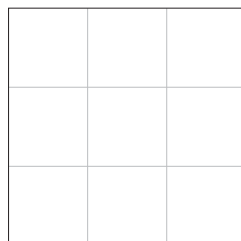
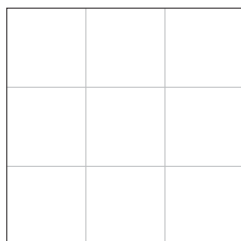
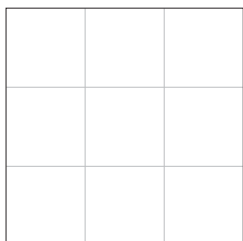
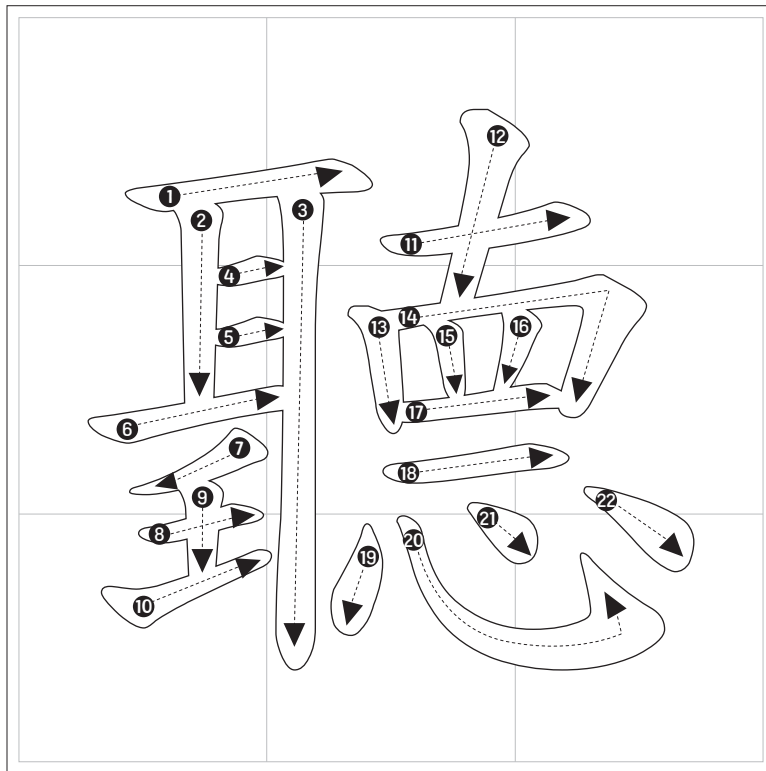

Sagebooks Character Tracing Sheet 2.1 Traditional

