

# Sagebooks Character Tracing Sheet 1.1 Simplified

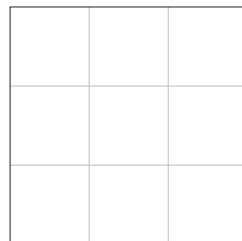

# Sagebooks Character Tracing Sheet 1.1 Simplified

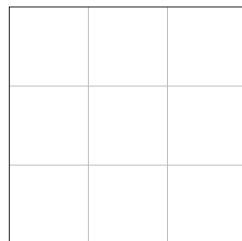
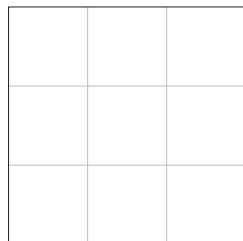
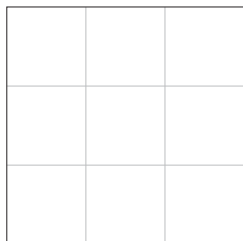
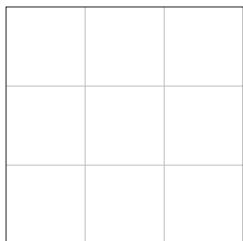
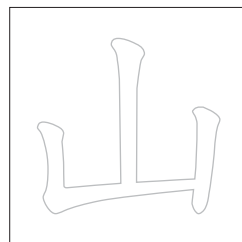
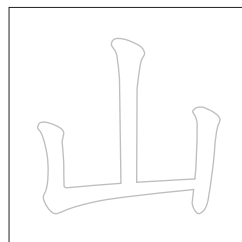
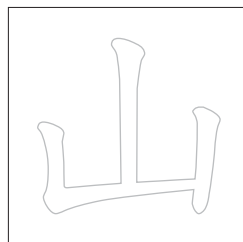
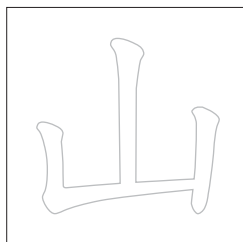
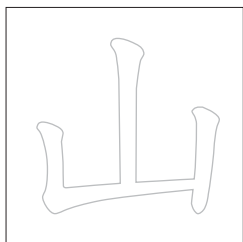
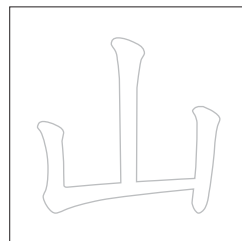
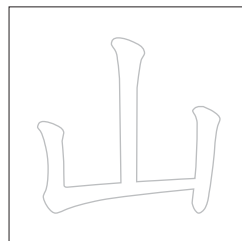
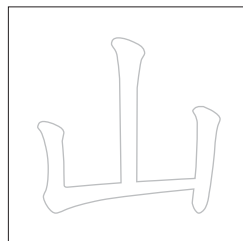
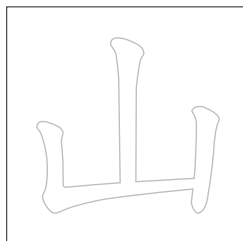
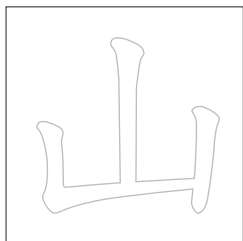
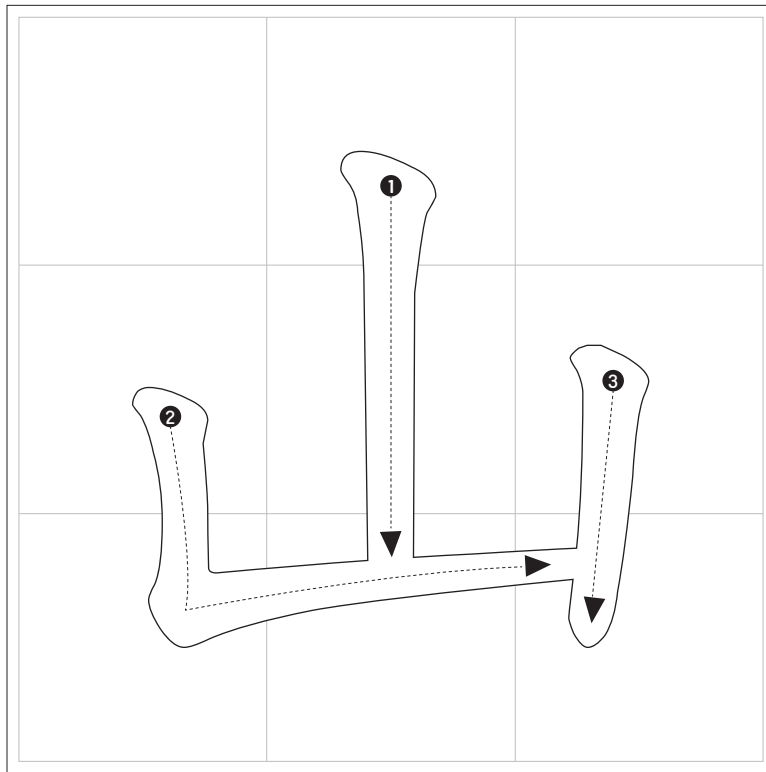
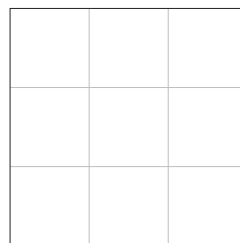
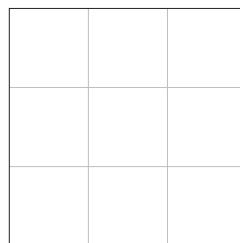
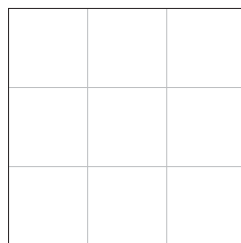
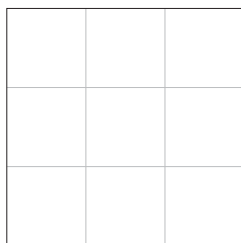
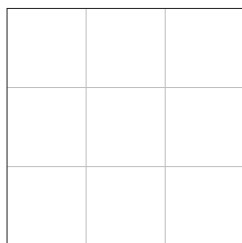
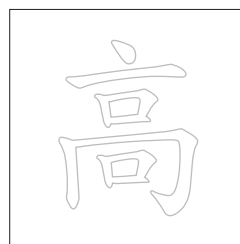
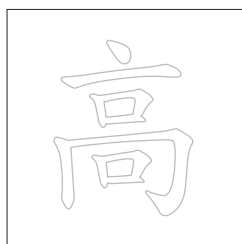
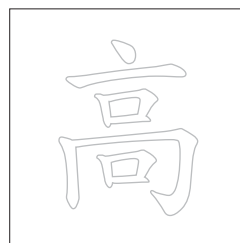
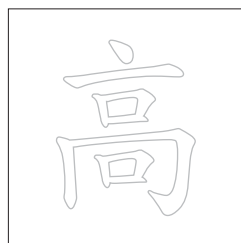
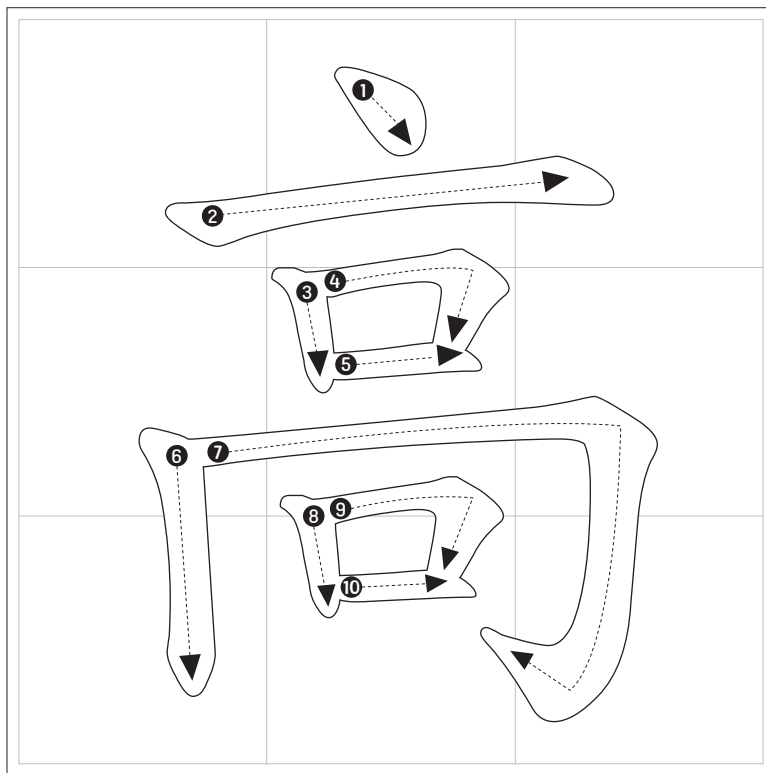

# Sagebooks Character Tracing Sheet 1.1 Simplified

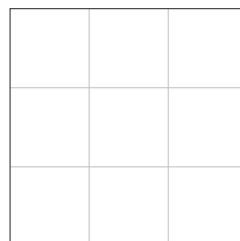
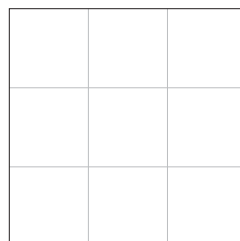
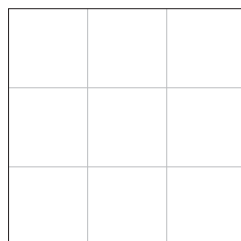
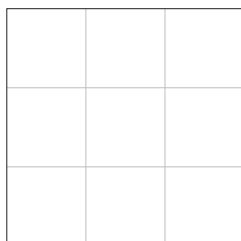
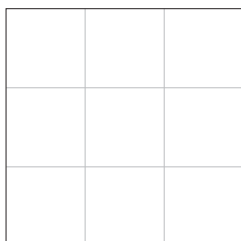
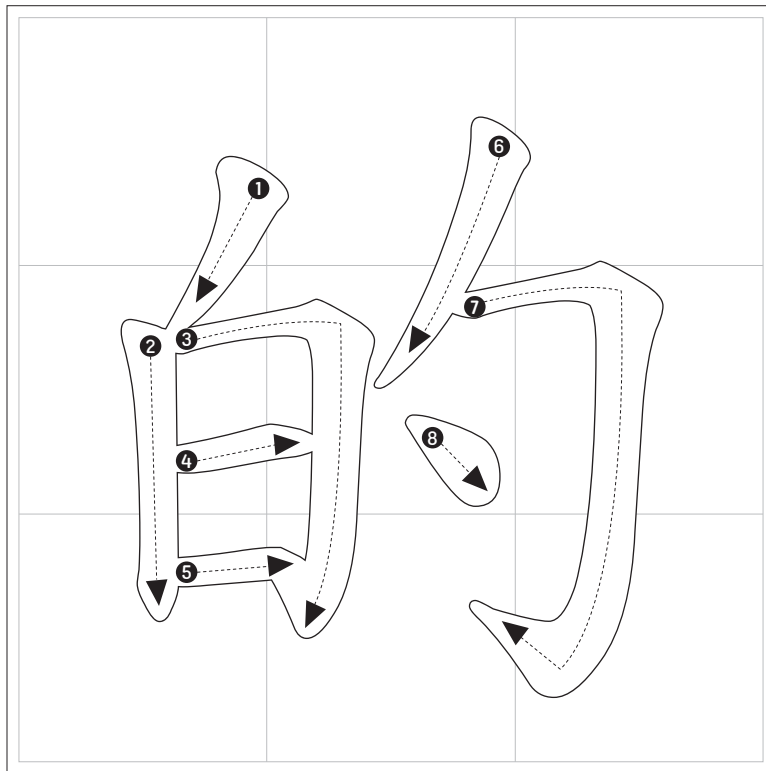

# Sagebooks Character Tracing Sheet 1.1 Simplified

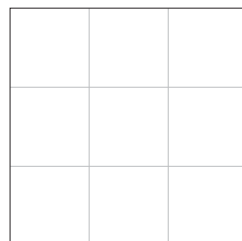
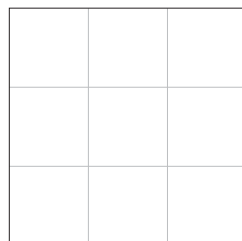
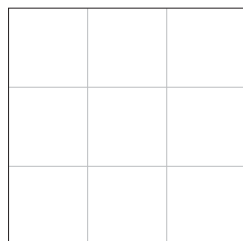
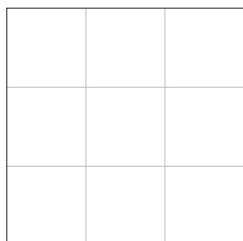
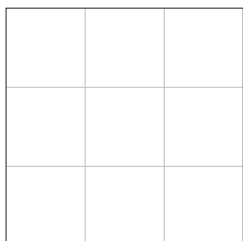
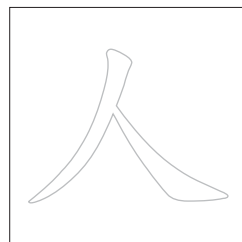
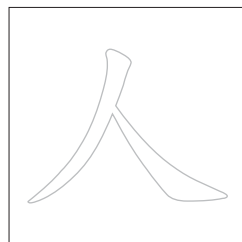
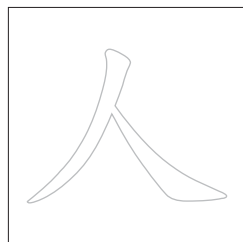
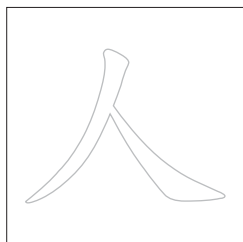
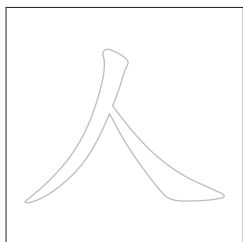
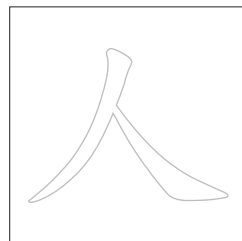
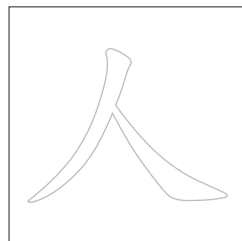
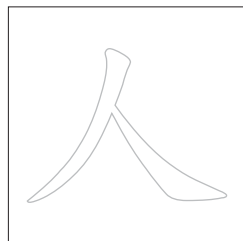
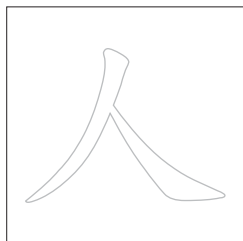
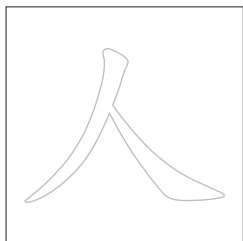
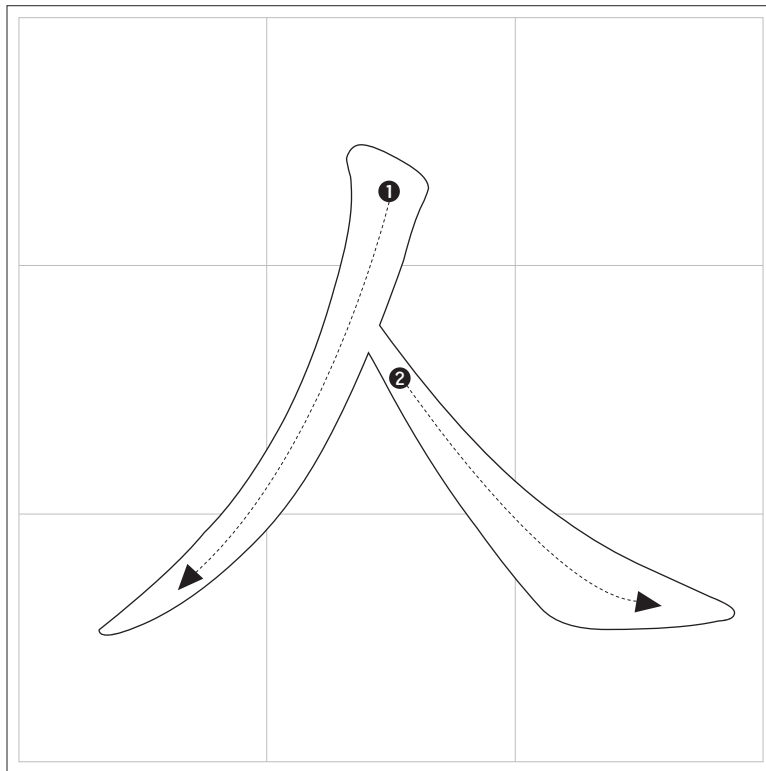

# Sagebooks Character Tracing Sheet 1.1 Simplified

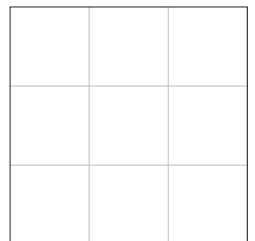
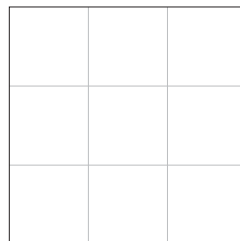
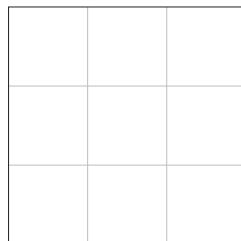
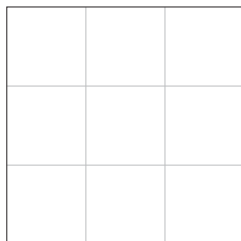
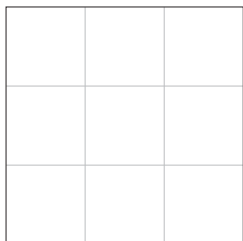
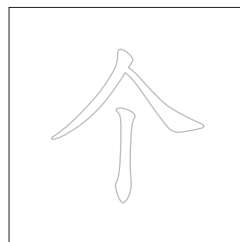
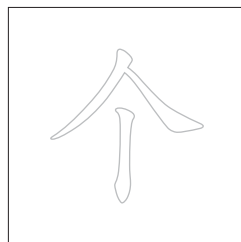
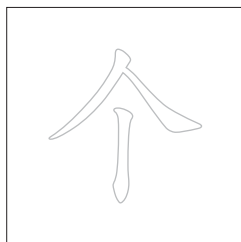
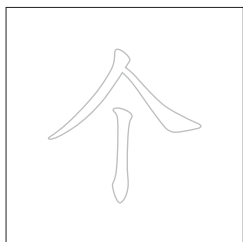
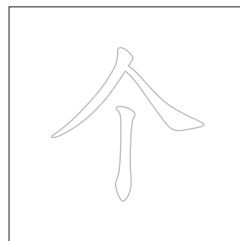
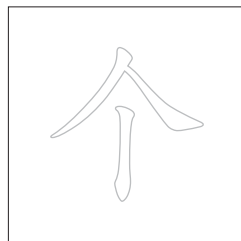
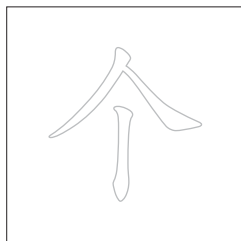
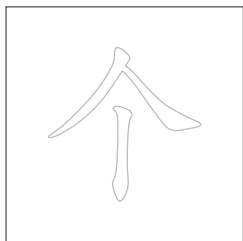
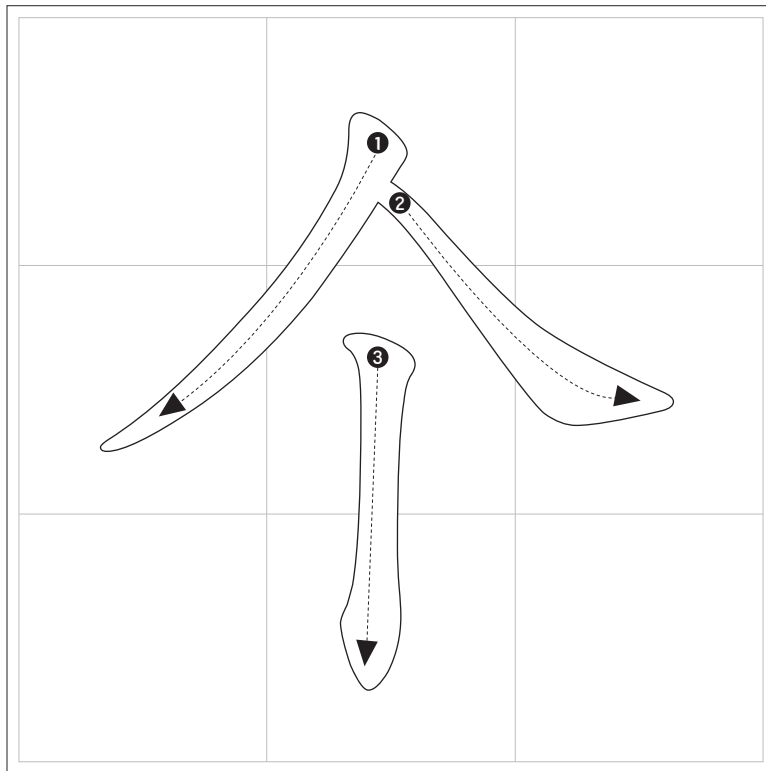

# Sagebooks Character Tracing Sheet 1.1 Simplified

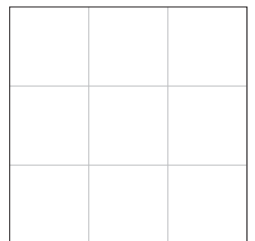
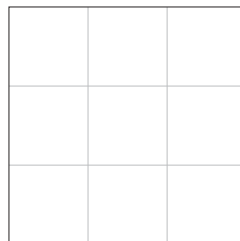
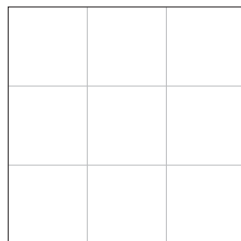
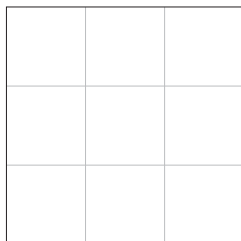
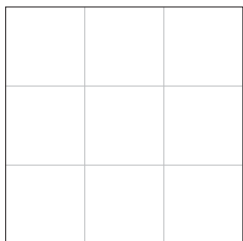
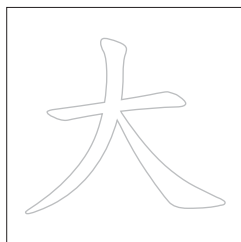
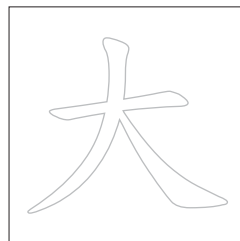
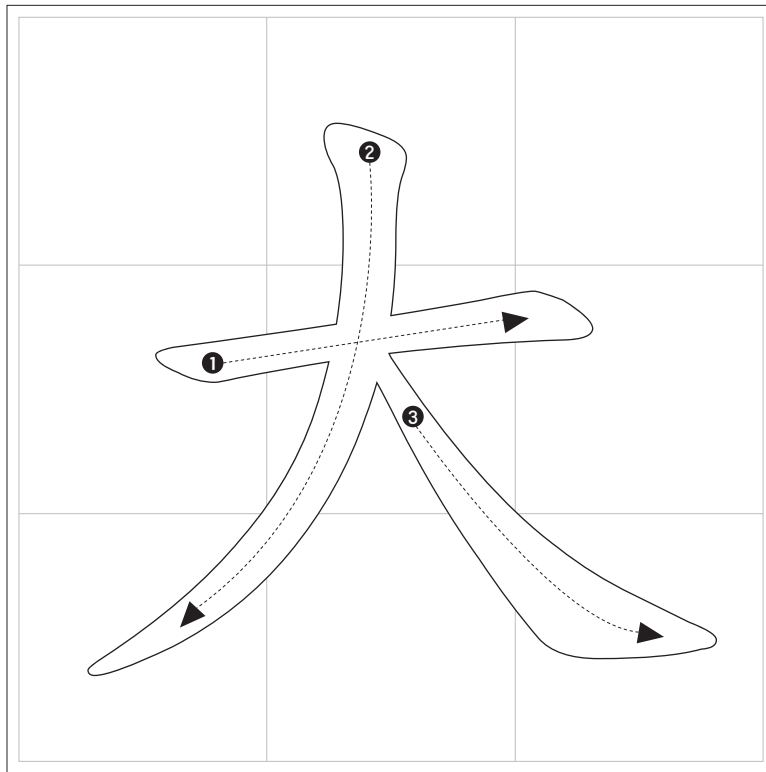

# Sagebooks Character Tracing Sheet 1.1 Simplified

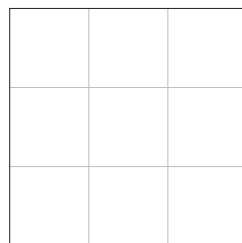
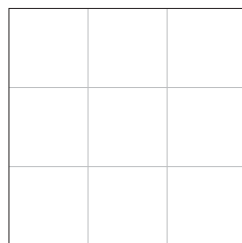
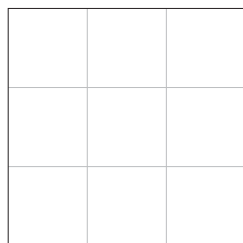
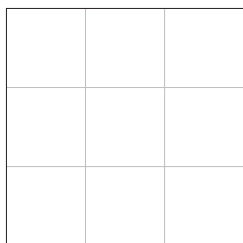
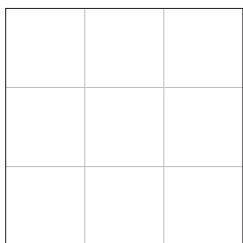
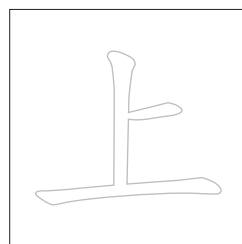
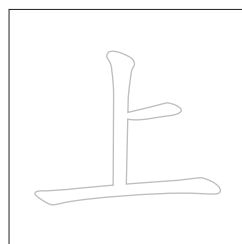
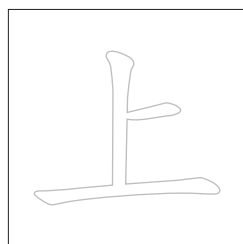
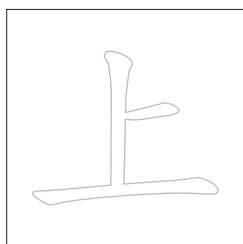
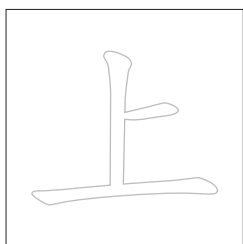
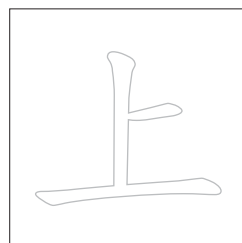
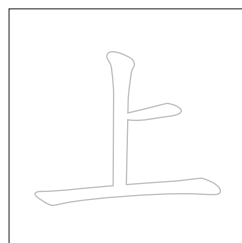
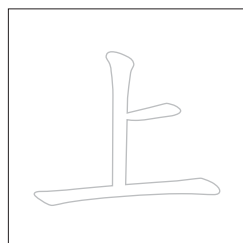
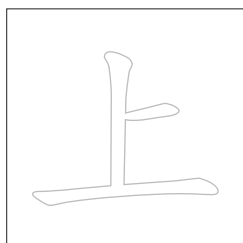
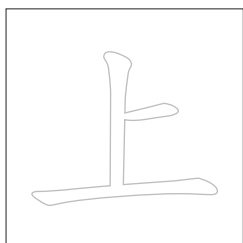
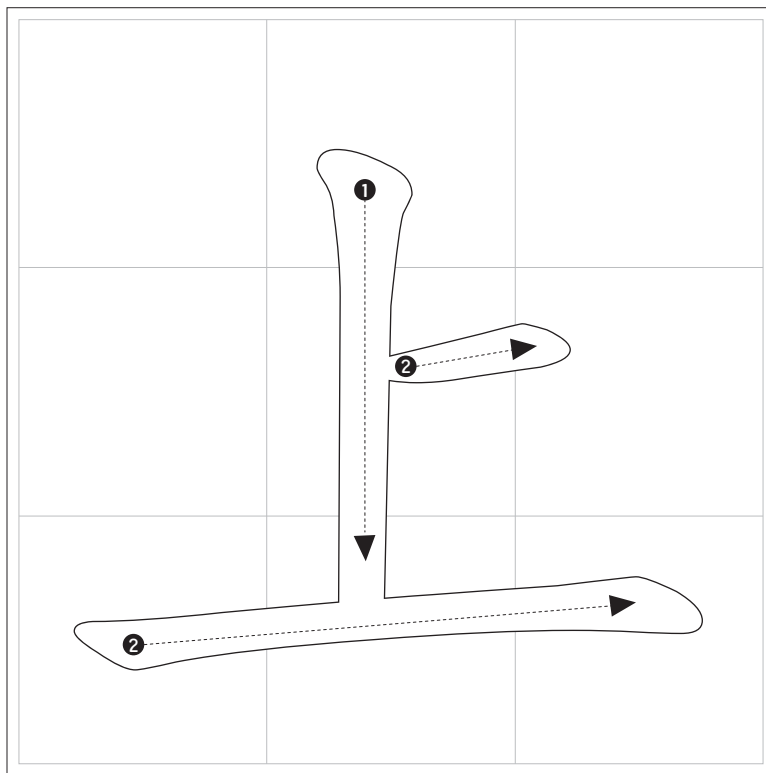

# Sagebooks Character Tracing Sheet 1.1 Simplified

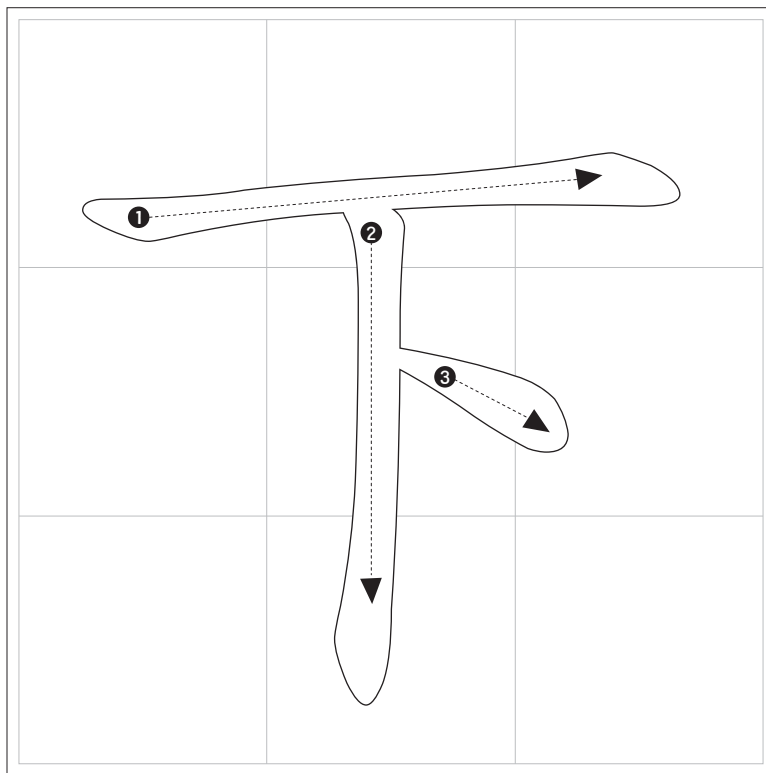



# Sagebooks Character Tracing Sheet 1.1 Simplified

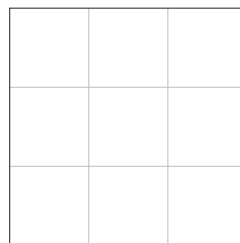
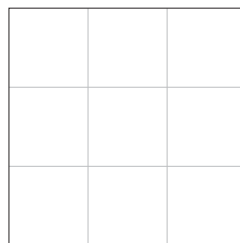
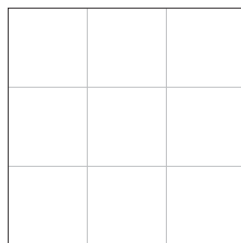
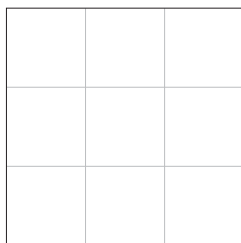
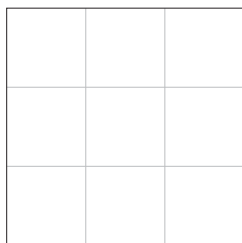
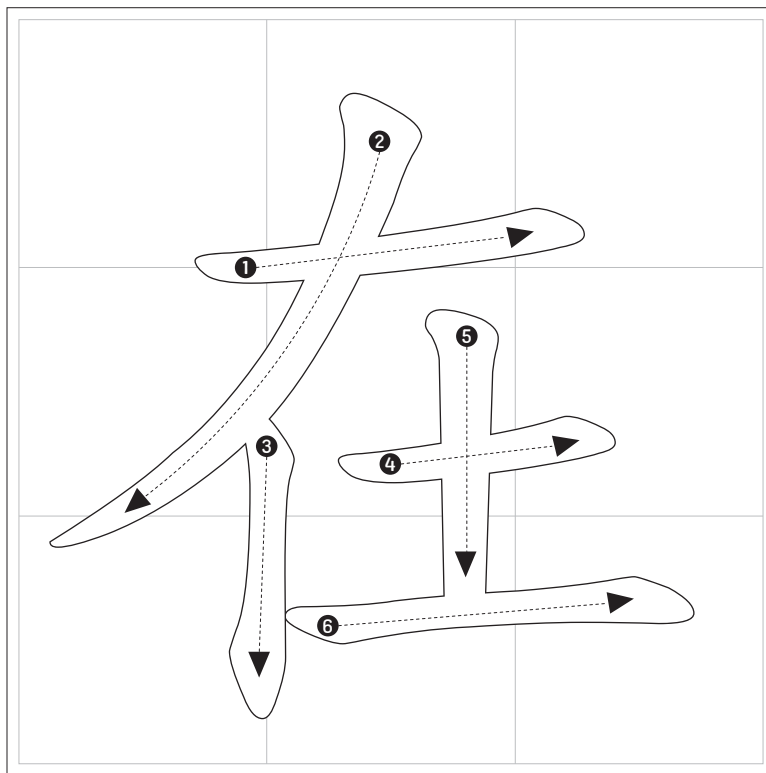

# Sagebooks Character Tracing Sheet 1.1 Simplified

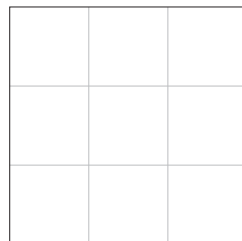
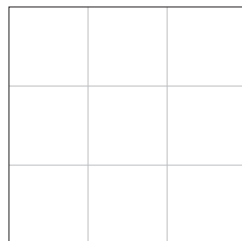
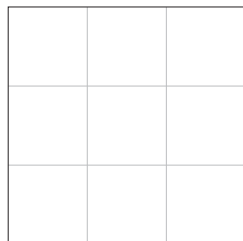
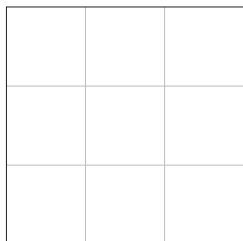
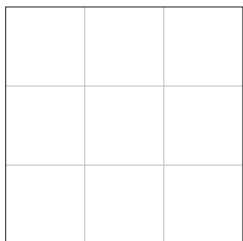
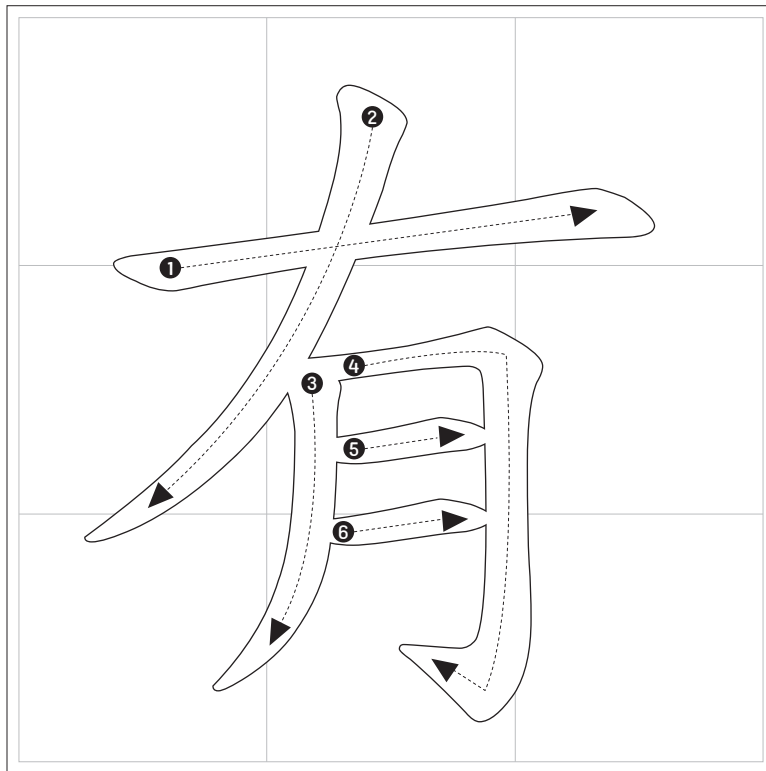

# Sagebooks Character Tracing Sheet 1.1 Simplified

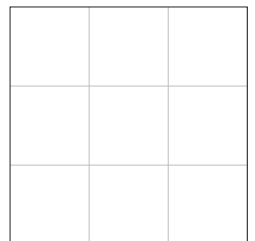
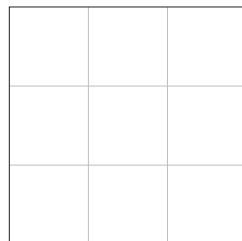
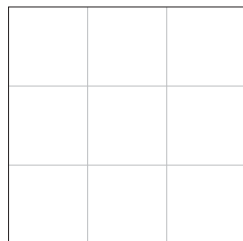
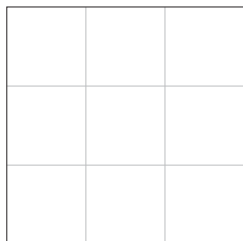
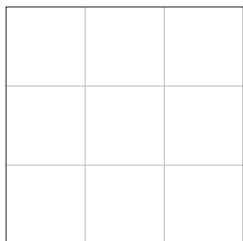
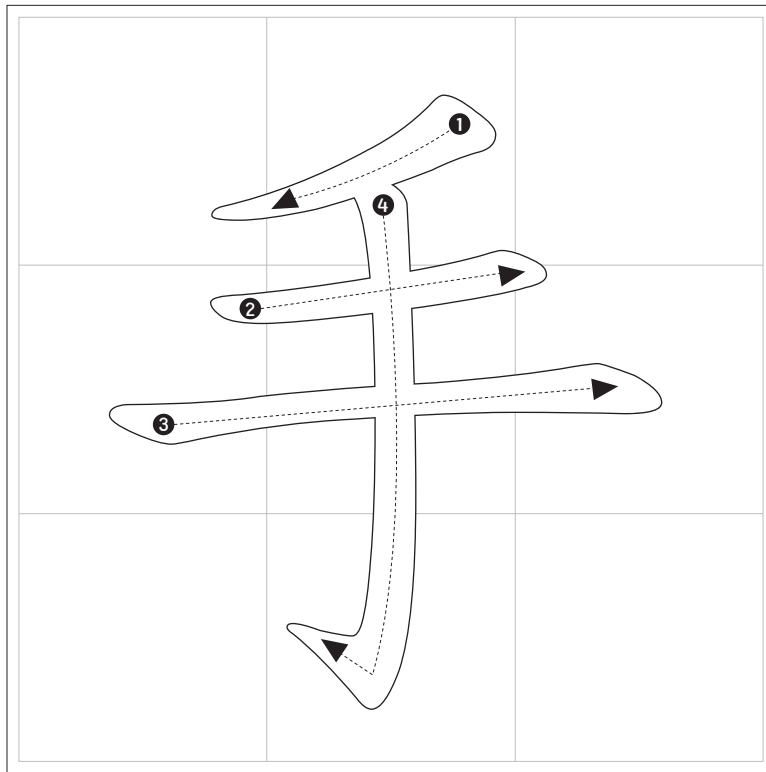

# Sagebooks Character Tracing Sheet 1.1 Simplified

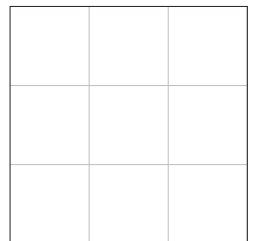
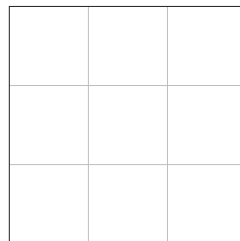
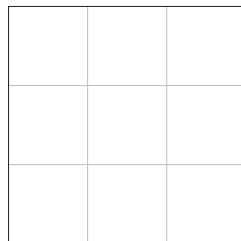
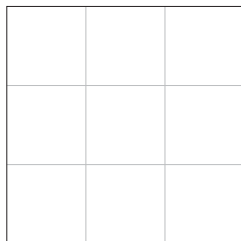
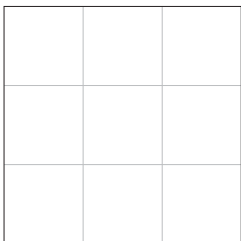
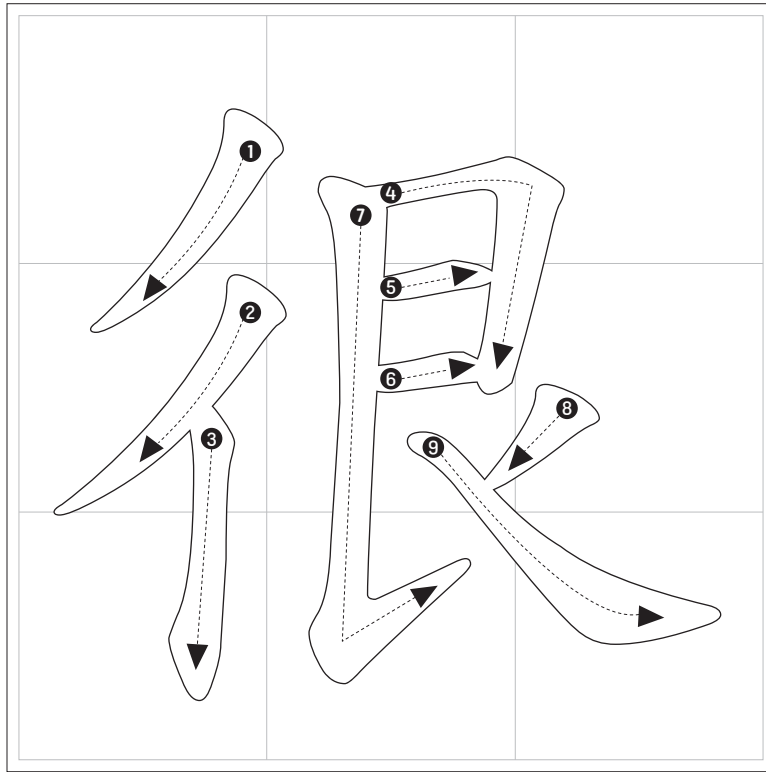

# Sagebooks Character Tracing Sheet 1.1 Simplified

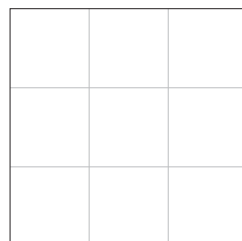
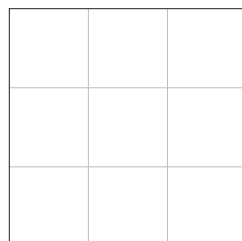
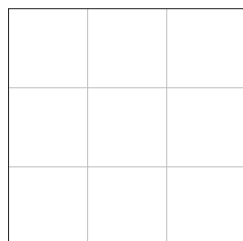
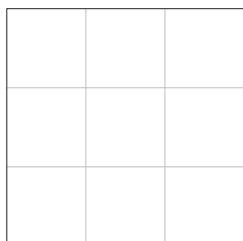
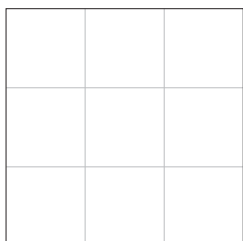
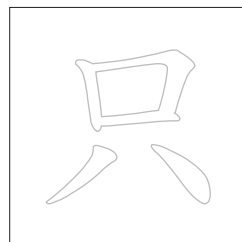
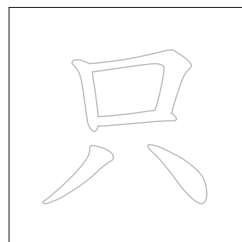
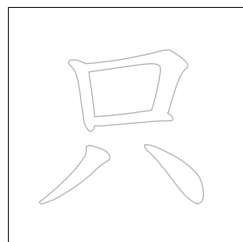
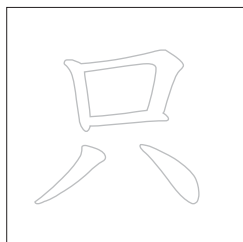
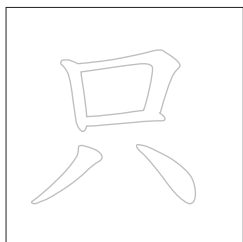
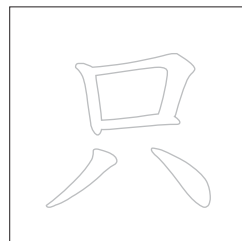
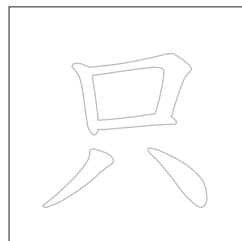
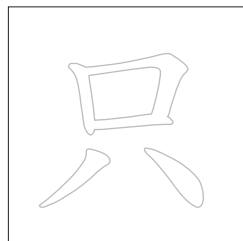
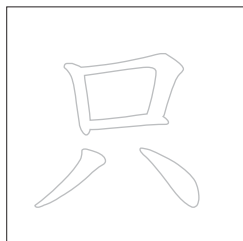
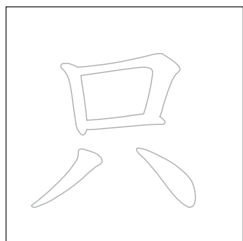
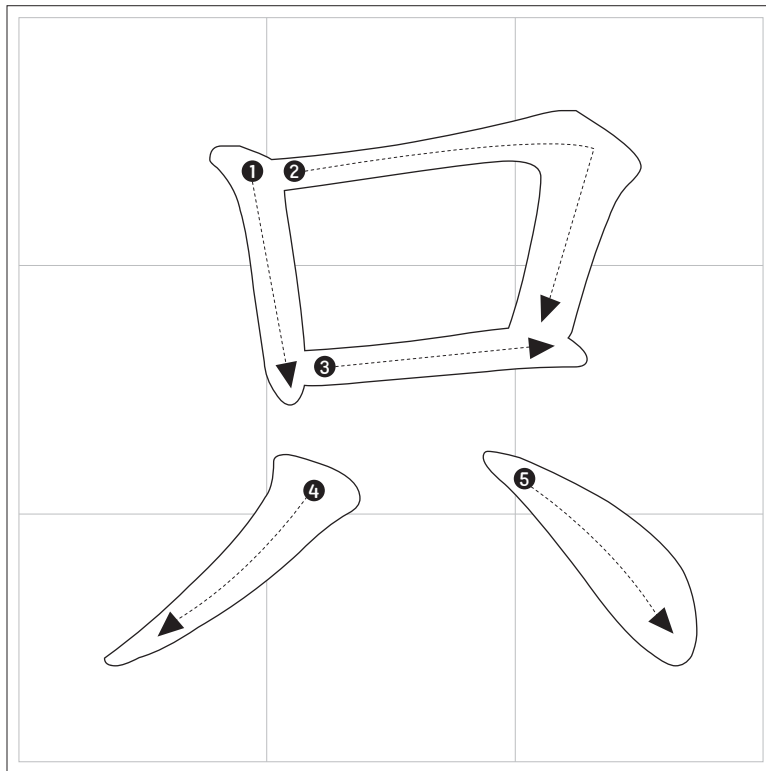

# Sagebooks Character Tracing Sheet 1.1 Simplified

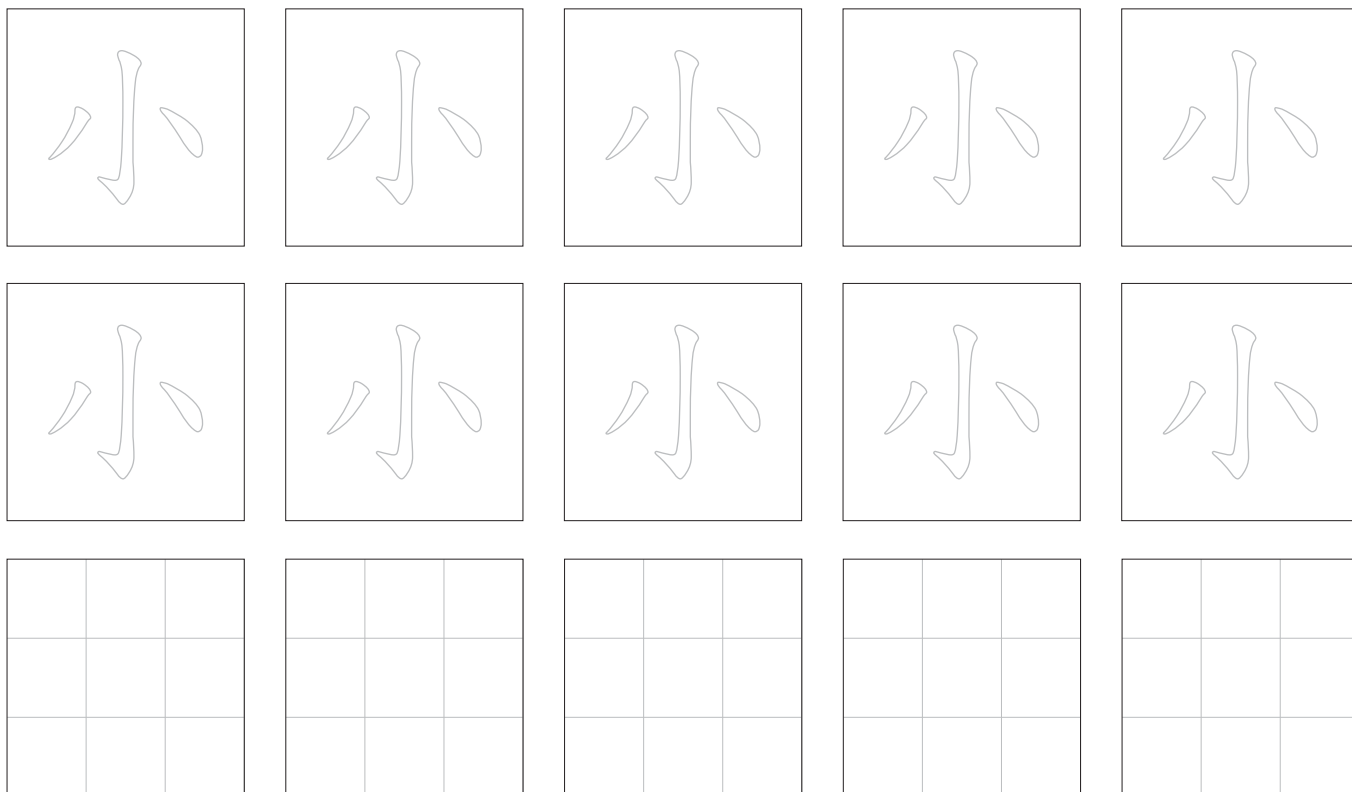
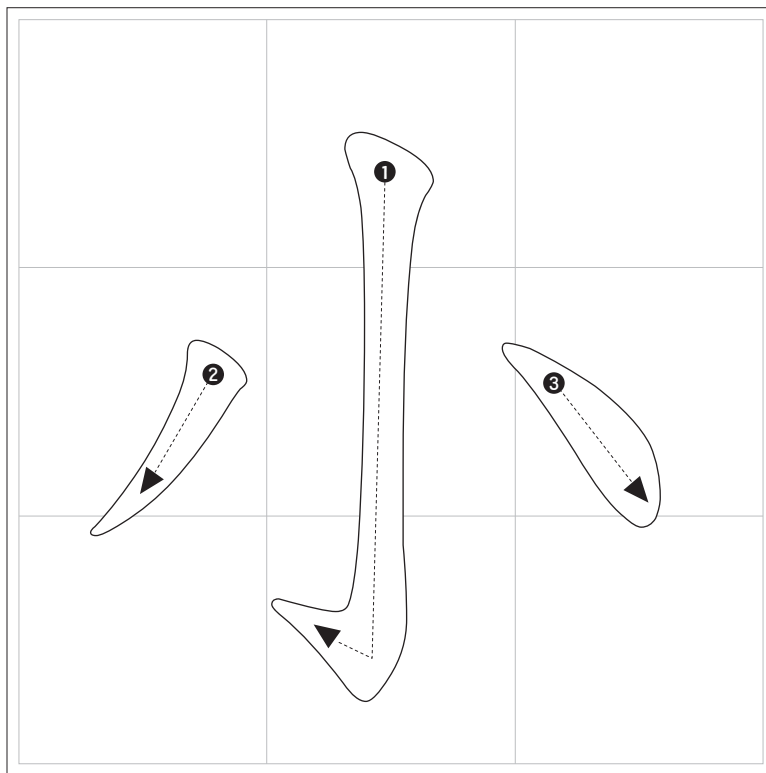

# Sagebooks Character Tracing Sheet 1.1 Simplified

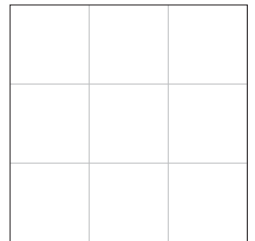
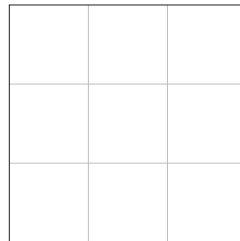
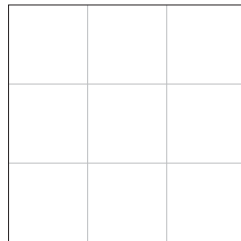
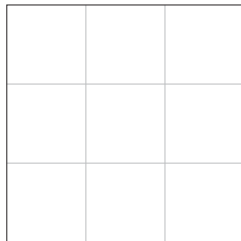
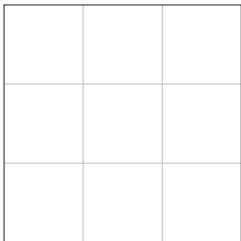
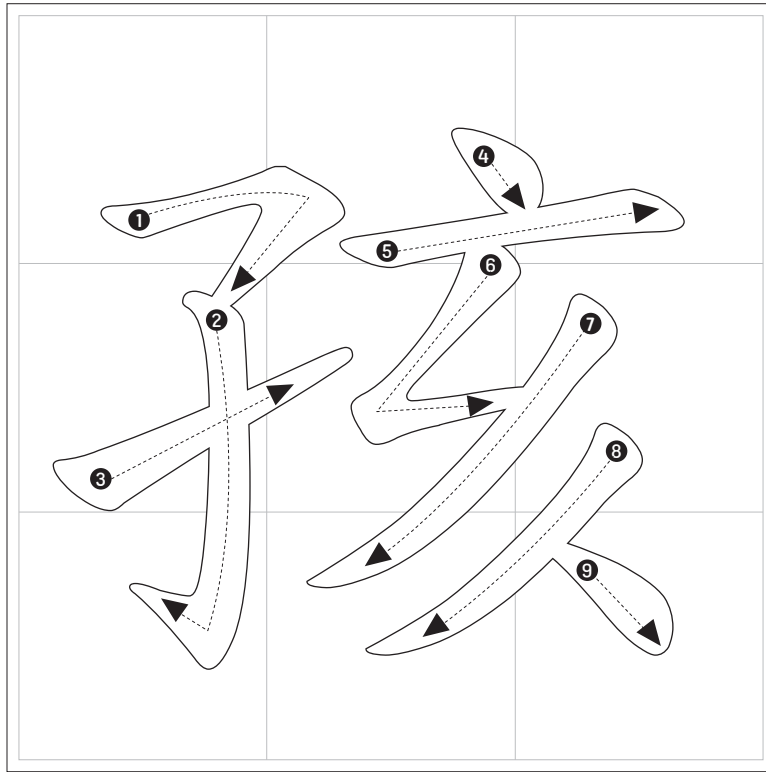

# Sagebooks Character Tracing Sheet 1.1 Simplified

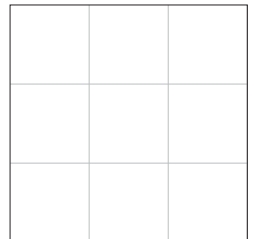
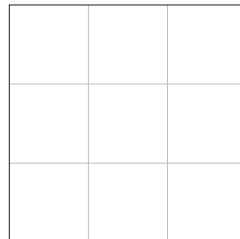
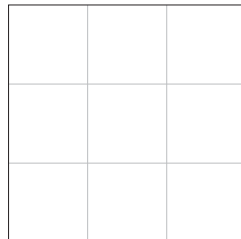
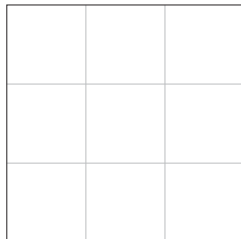
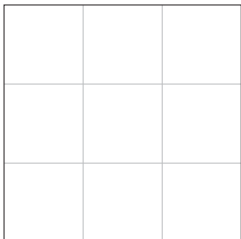
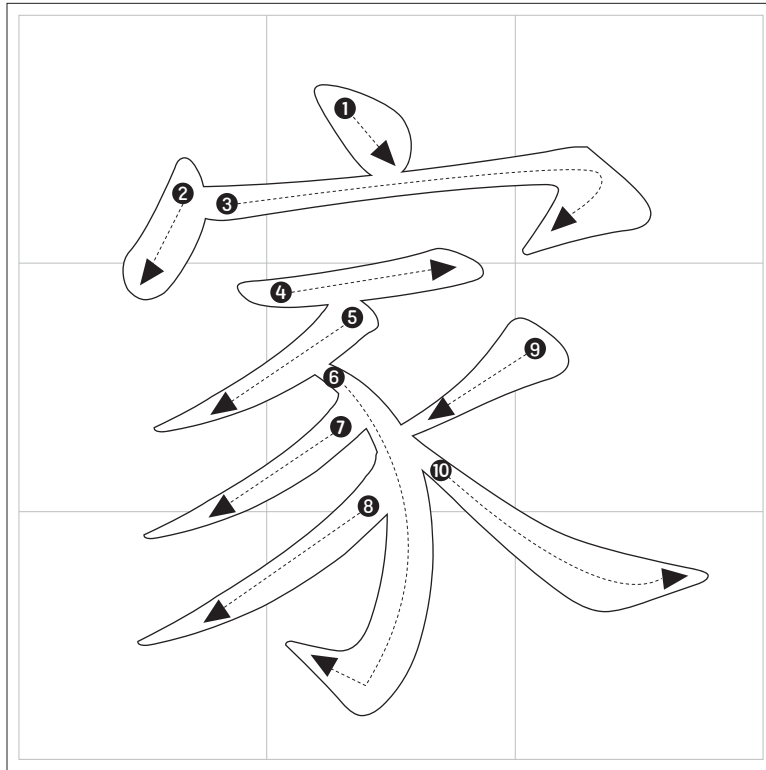



# Sagebooks Character Tracing Sheet 1.1 Simplified

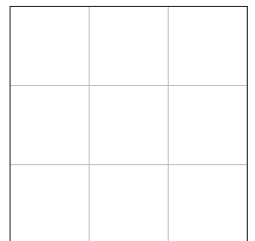
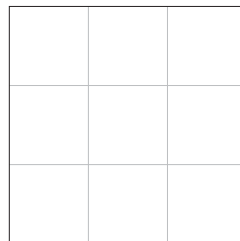
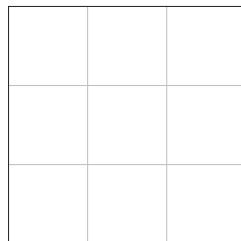
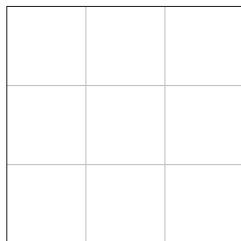
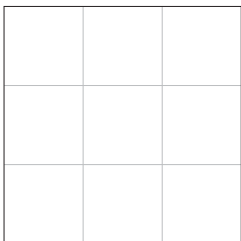
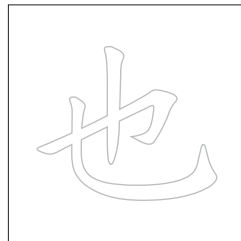
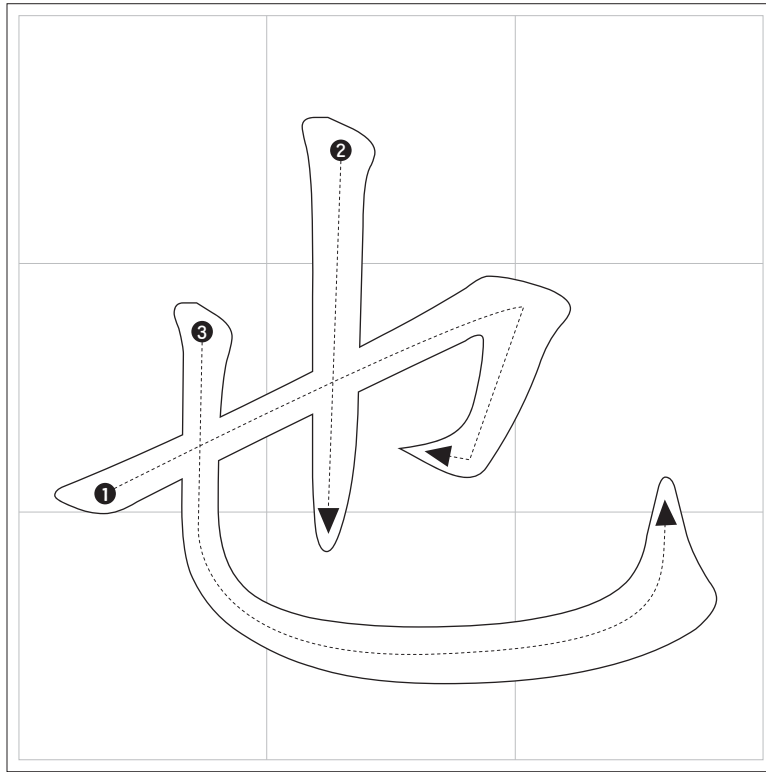

# Sagebooks Character Tracing Sheet 1.1 Simplified

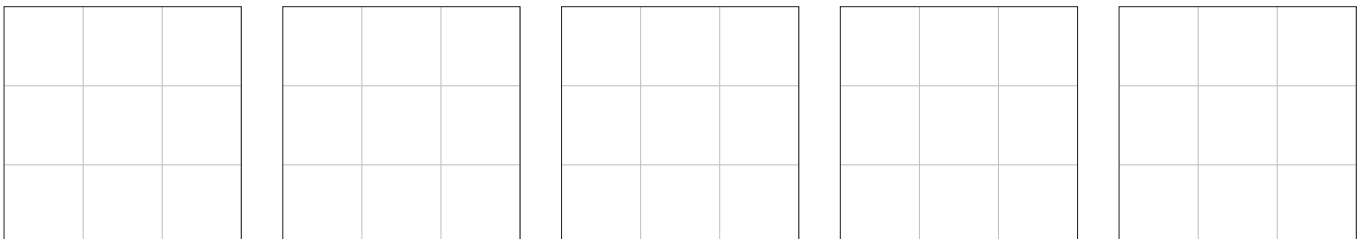
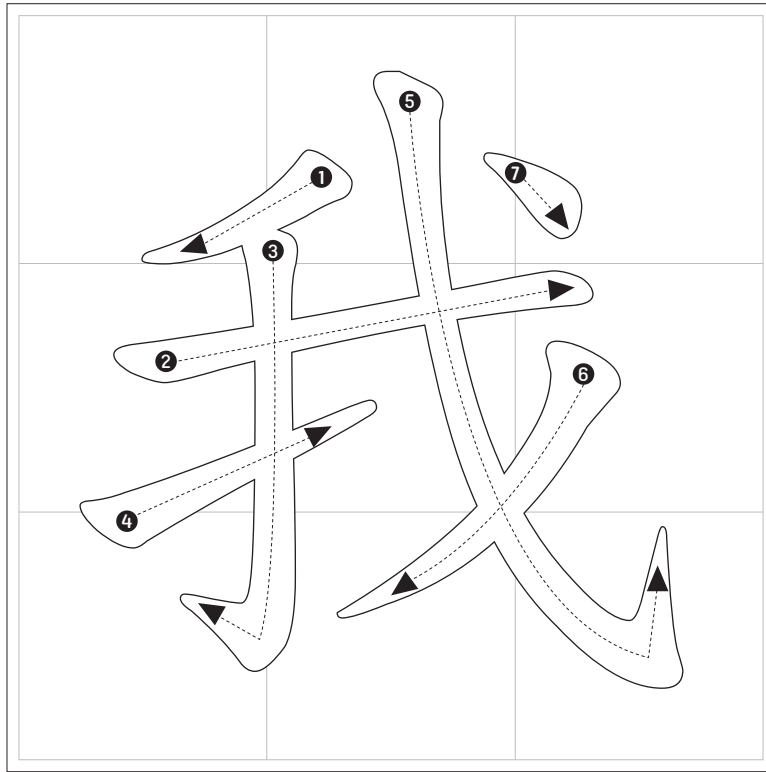

# Sagebooks Character Tracing Sheet 1.1 Simplified

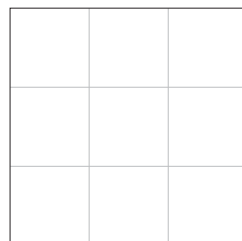
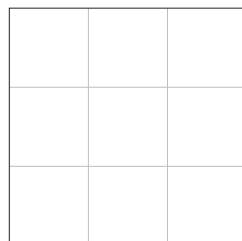
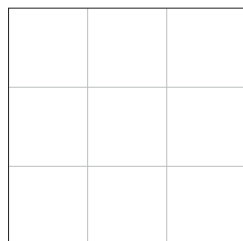
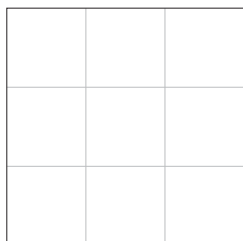
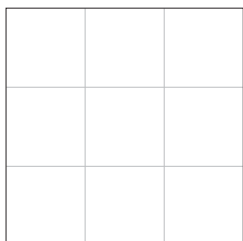
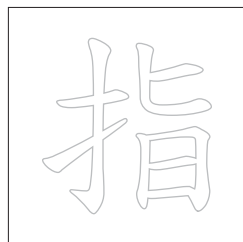
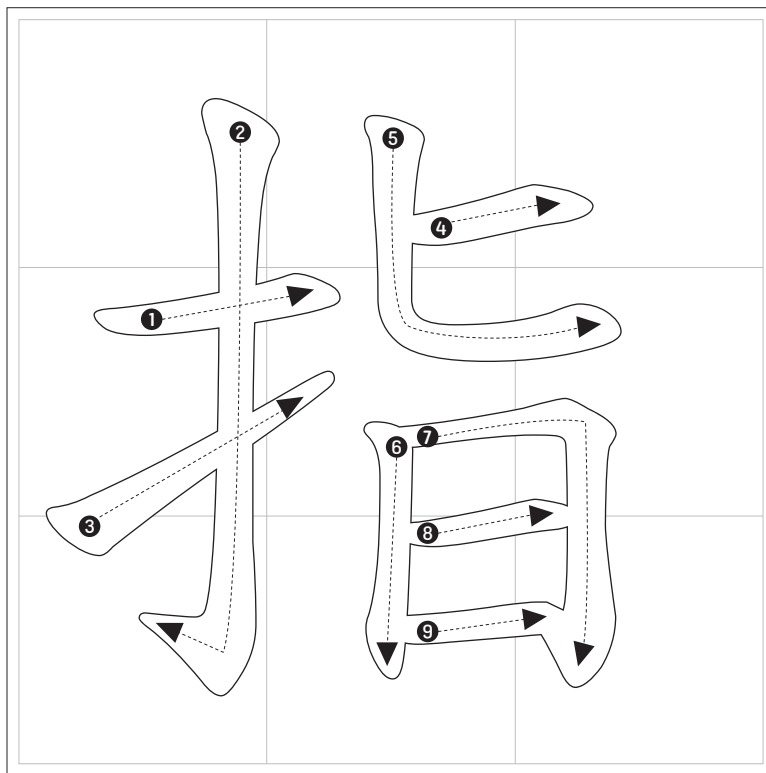

# Sagebooks Character Tracing Sheet 1.1 Simplified

